

coleção

# ATIVIDADES PARA TODO DIA

# JOGOS

## E ATIVIDADES

PARA

## ALFABETIZAÇÃO

VOLUME 2

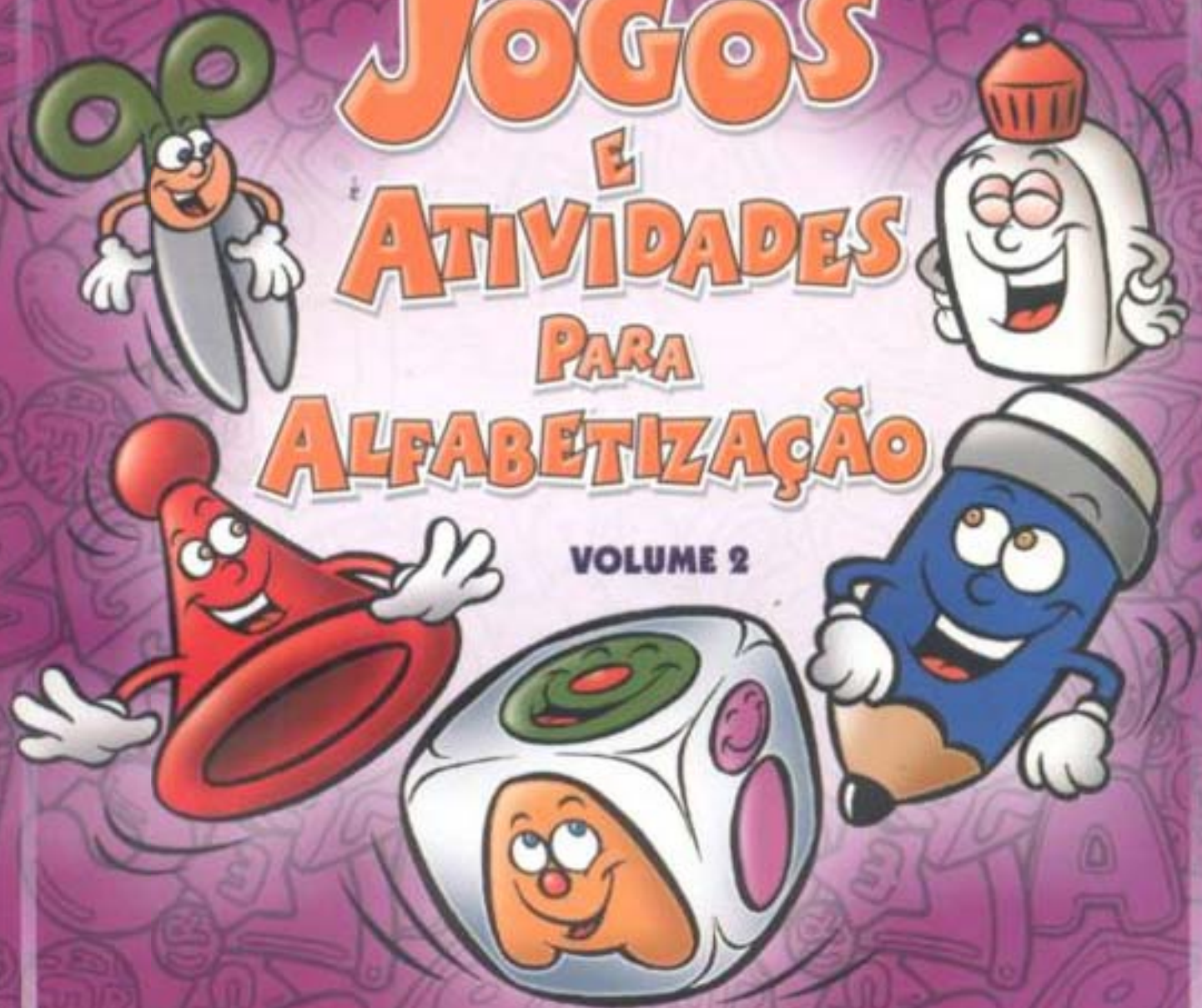

**ELABORADA DE ACORDO COM OS PCN'S**

VERA M. LIMA E SILVA  
FLÁVIA MARQUES



# ORDEM ALFABÉTICA

ESCREVA EM ORDEM ALFABÉTICA OS NOMES DAS FIGURAS DE CADA GRUPO.

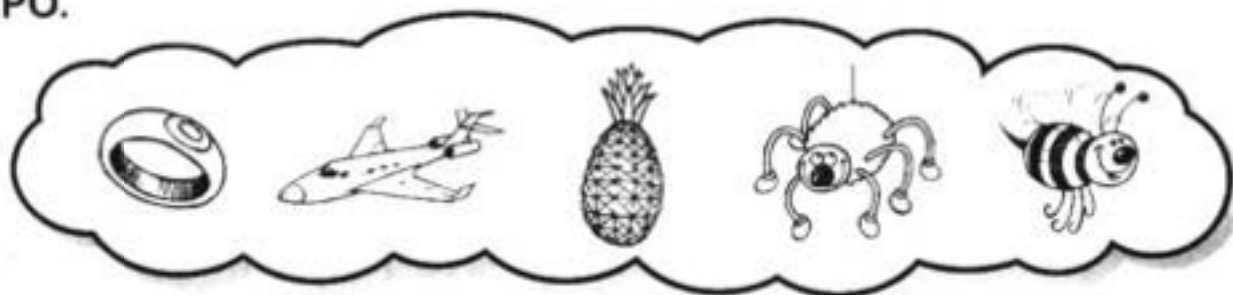

---

---

---

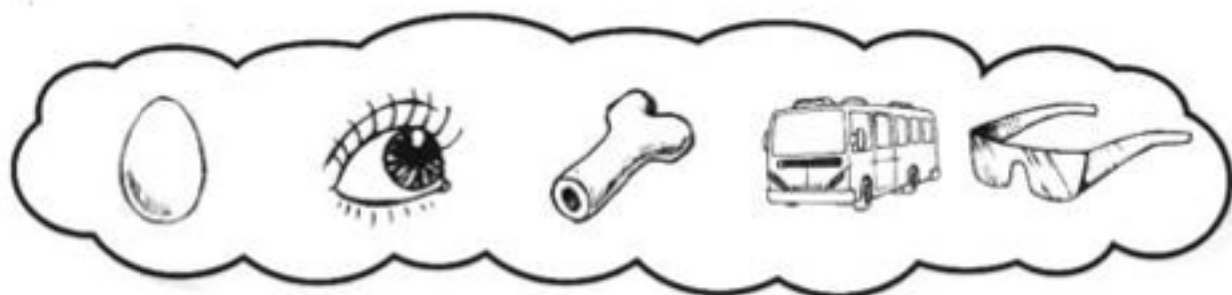

---

---

---

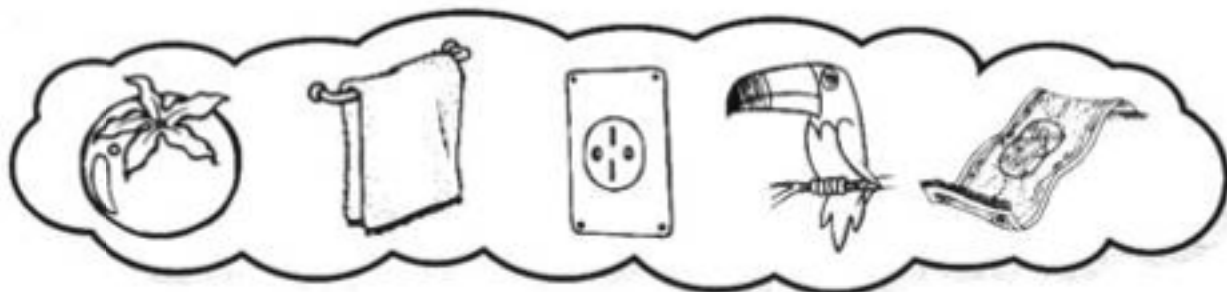

---

---

---



# ORDEM ALFABÉTICA

ESCREVA O NOME DE CADA HISTÓRIA, NUMERE NA ORDEM ALFABÉTICA E DEPOIS ESCREVA NA SEQÜÊNCIA ABAIXO.

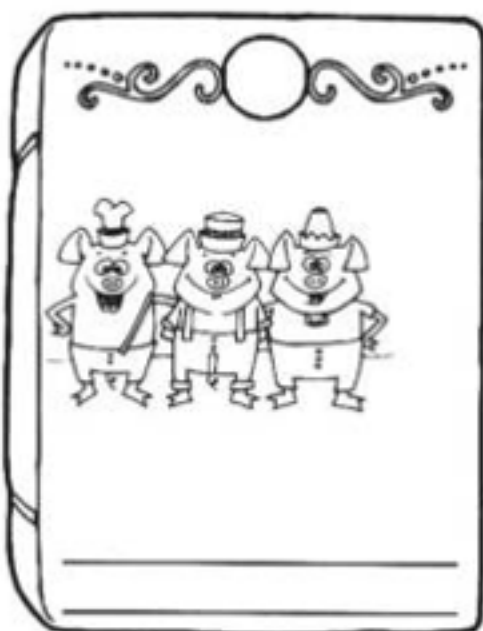
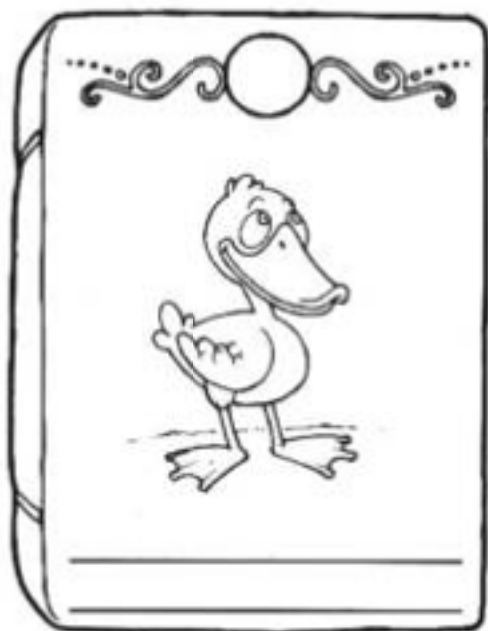

Four horizontal lines for writing the sequence of stories.



# PENSE BEM

LEIA AS DICAS E ESCREVA QUAL A FRUTA PREFERIDA DE CADA CRIANÇA.

**FELIPE**



**GABRIELA**



**MARINA**



A MENINA DE CABELOS LONGOS GOSTA DA FRUTA QUE COMEÇA E TERMINA COM VOGAL.

O MENINO DE TOPETE GOSTA DA FRUTA ESCRITA COM 8 LETRAS.

A MENINA DE ÓCULOS GOSTA DA FRUTA QUE TERMINA COM A LETRA "O".

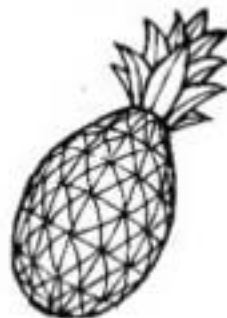

# SÓ VALE VOGAL

ESCREVA SOMENTE OS NOMES DAS FIGURAS QUE COMEÇAM COM VOGAL.

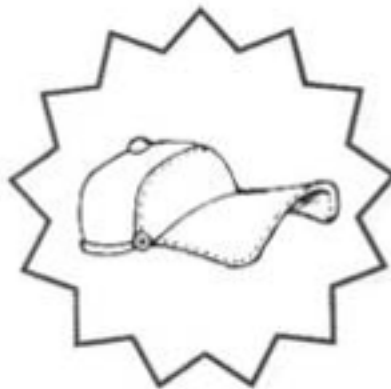

# PALAVRAS E LETRAS

ESCREVA AS PALAVRAS QUE VOCÊ CONHECE COM:

**1 LETRA**

A large rectangular box with horizontal lines for writing, intended for one-letter words.



**2 LETRAS**

A large rectangular box with horizontal lines for writing, intended for two-letter words.



**3 LETRAS**

A large rectangular box with horizontal lines for writing, intended for three-letter words.



**4 LETRAS**

A large rectangular box with horizontal lines for writing, intended for four-letter words.



**5 LETRAS**

A large rectangular box with horizontal lines for writing, intended for five-letter words.



**6 LETRAS**

A large rectangular box with horizontal lines for writing, intended for six-letter words.



# LIGUE-LIGUE

LIGUE CADA FIGURA AO SEU NOME.



**CADEIRA**

**ALMOFADA**

**SOFÁ**

**FOGÃO**

**TESOURA**

**ARMÁRIO**

**TORNEIRA**

**ESCADA**

**MESA**

**ESPELHO**

**PORTA**

**JANELA**

ALGUMA PALAVRA FICOU SEM FIGURA CORRESPONDENTE? QUAL OU  
QUAIS? ESCREVA-AS ABAIXO.

---

---

---



# TROCA-TROCA

TROQUE O SÍMBOLO PELA LETRA E ESCREVA UMA CANTIGA TRADICIONAL

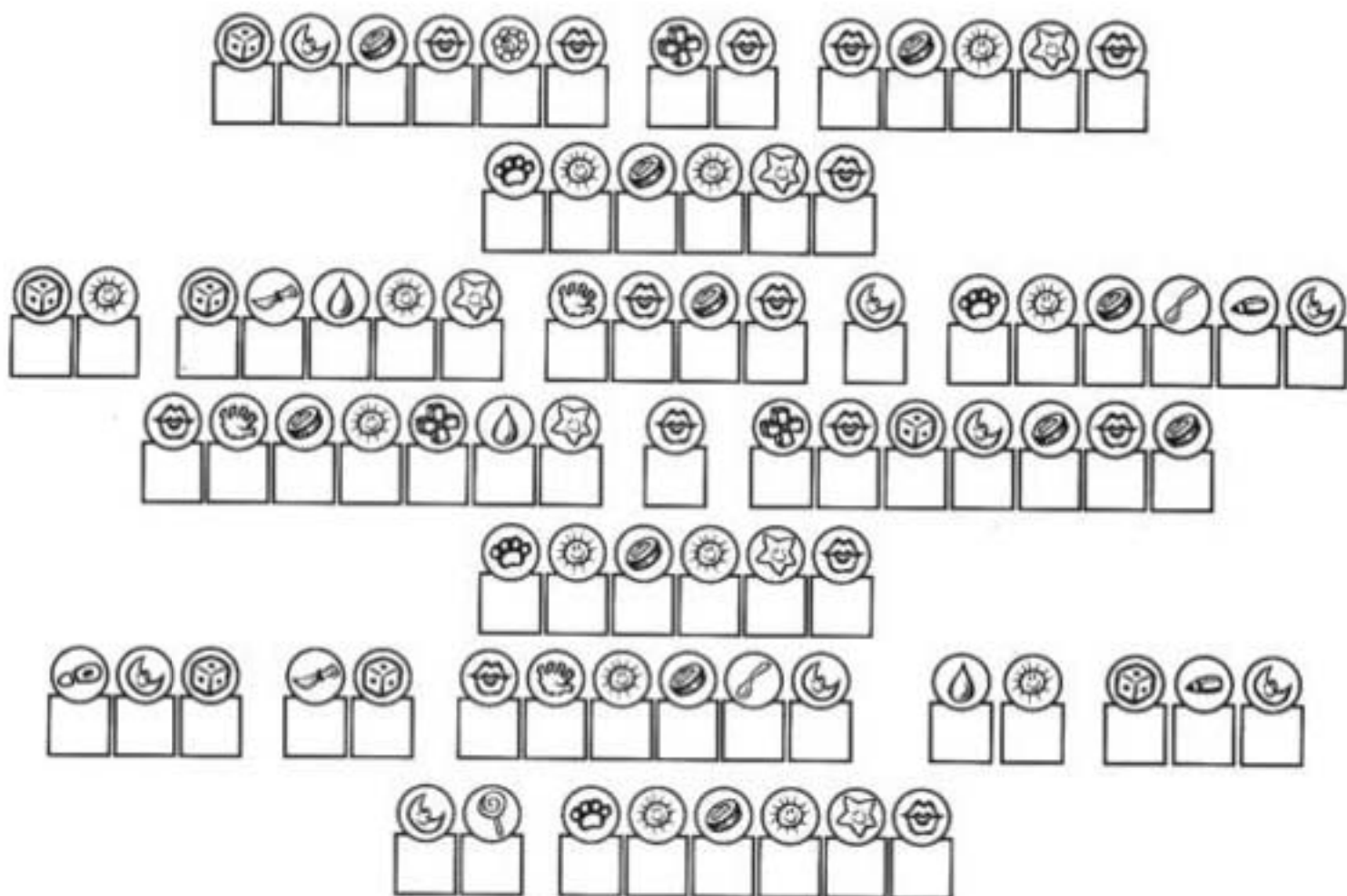



# CAÇA-NOMES

QUAL DAS FIGURAS TEM O NOME ESCRITO ENTRE AS LETRAS ABAIXO?  
MARQUE-O E ESCREVA-O JUNTO À FIGURA.

**CABILCADERNOCAMEMO**



**DACAFIAGTAFADAFOFIO**



**GOPORPPARTAPATOGO**



**CACABAXICARAGAXICA**





# OLHO VIVO

ESTÃO FALTANDO LETRAS NOS NOMES DAS FIGURAS. REESCREVA-AS NA LINHA E DEPOIS LIGUE CADA NOME À FIGURA CERTA.



GFANHOT: \_\_\_\_\_



MACCO: \_\_\_\_\_



ELFATE: \_\_\_\_\_

OELHO: \_\_\_\_\_



PRCO: \_\_\_\_\_

ACRÉ: \_\_\_\_\_



MRCGO: \_\_\_\_\_

ATU: \_\_\_\_\_



RSO: \_\_\_\_\_

FRMGA: \_\_\_\_\_



GRAF: \_\_\_\_\_

CMELO: \_\_\_\_\_



RNOCRONT: \_\_\_\_\_

SQILO: \_\_\_\_\_



TAMADUÁ: \_\_\_\_\_

CAORRO: \_\_\_\_\_



IGRE: \_\_\_\_\_

ALIHA: \_\_\_\_\_



PAPGAO: \_\_\_\_\_

BLIA: \_\_\_\_\_



# CAÇA-PALAVRAS

ENCONTRE NO DIAGRAMA OS NOMES DAS FIGURAS E ESCREVA-OS JUNTO A CADA UMA.

|   |   |   |   |   |   |   |   |   |   |   |   |   |   |
|---|---|---|---|---|---|---|---|---|---|---|---|---|---|
| B | A | F | R | E | G | B | C | U | O | P | H | E | G |
| O | E | E | G | H | J | Q | A | B | V | F | I | G | X |
| R | V | H | J | K | N | M | B | P | L | R | P | D | F |
| B | H | F | C | O | M | P | U | T | A | D | O | R | E |
| O | D | E | R | F | C | D | S | Q | U | Y | P | N | C |
| L | H | T | B | V | F | E | I | R | C | J | O | G | H |
| E | F | R | D | V | H | J | N | M | B | G | T | R | A |
| T | R | A | V | E | S | S | E | I | R | O | A | D | D |
| A | D | E | G | C | O | Y | H | T | U | O | M | S | U |
| C | A | B | E | L | E | I | R | E | I | R | O | N | R |
| T | R | F | S | D | D | H | J | N | B | V | T | R | A |



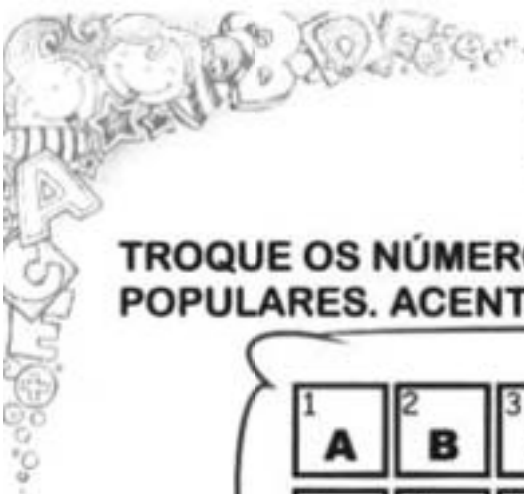

# TROCA-LETRAS

TROQUE OS NÚMEROS PELAS LETRAS E ESCREVA DUAS QUADRINHAS POPULARES. ACENTUE QUANDO NECESSÁRIO.

|    |    |    |    |    |    |    |    |    |    |
|----|----|----|----|----|----|----|----|----|----|
| 1  | 2  | 3  | 4  | 5  | 6  | 7  | 8  | 9  | 10 |
| A  | B  | C  | D  | E  | F  | G  | H  | I  | L  |
| 11 | 12 | 13 | 14 | 15 | 16 | 17 | 18 | 19 | 20 |
| M  | N  | O  | P  | R  | S  | T  | U  | V  | Ã  |

6-18-9 1 8-13-15-17-1 3-13-10-8-5-15 3-13-18-19-5  
 11-1-15-9-11-2-13-12-4-13 11-5 11-13-15-4-5-18  
 6-18-9 4-1-15 14-1-15-17-5 12-1 14-13-10-9-3-9-1  
 1 14-13-10-9-3-9-1 11-5 14-15-5-12-4-5-18



---



---



---



---

11-5-12-9-12-1 2-13-12-9-17-1  
 4-1 14-5-15-12-1 7-15-13-16-16-1  
 4-5 16-1-9-1 3-18-15-17-9-12-8-1  
 11-1-11-20-5 12-20-13 7-13-16-17-1



---



---



---



---

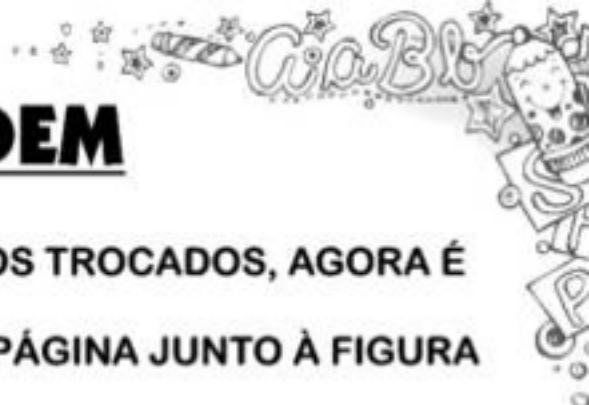

# TUDO EM ORDEM

OS NOMES DAS FIGURAS ABAIXO FORAM TODOS TROCADOS, AGORA É COM VOCÊ!  
RECORTE OS NOMES E COLE-OS NA PRÓXIMA PÁGINA JUNTO À FIGURA CORRESPONDENTE.

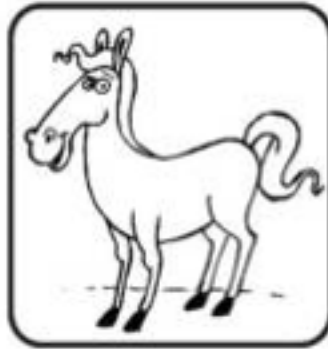

CAMELO

HIPOPÓTAMO

MORCEGO

BODE

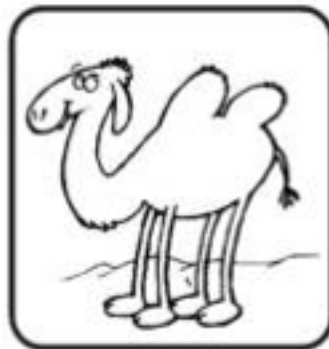

BOI

GATO

CACHORRO

SAPO

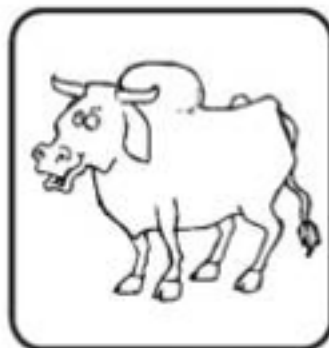
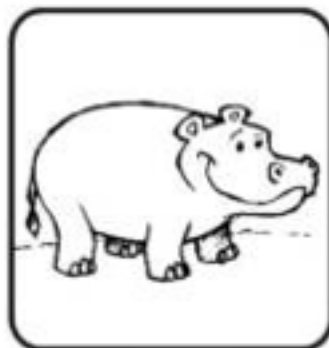

COELHO

MACACO

ELEFANTE

CAVALO



\_\_\_\_\_



\_\_\_\_\_



\_\_\_\_\_



\_\_\_\_\_



\_\_\_\_\_



\_\_\_\_\_



\_\_\_\_\_

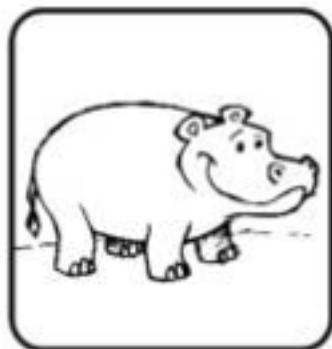

\_\_\_\_\_



\_\_\_\_\_



\_\_\_\_\_



\_\_\_\_\_

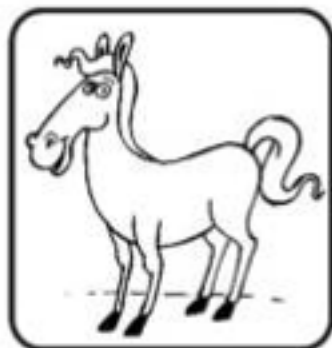





\_\_\_\_\_



# DECIFRANDO

ESCREVA AS LETRAS DE ACORDO COM AS DICAS E ENCONTRE A PALAVRA MISTERIOSA.

- 1 - SEGUNDA LETRA DO ALFABETO.
- 2 - LETRA QUE VEM ANTES DO B.
- 3 - TERCEIRA VOGAL.
- 4 - ÚLTIMA LETRA DE .
- 5 - PRIMEIRA LETRA DE .
- 6 - LETRA QUE VEM ANTES DO S.
- 7 - LETRA QUE VEM ANTES DO J.
- 8 - TERCEIRA LETRA DE .
- 9 - ÚLTIMA LETRA DE .

|          |          |          |          |          |          |          |          |          |
|----------|----------|----------|----------|----------|----------|----------|----------|----------|
| <b>1</b> | <b>2</b> | <b>3</b> | <b>4</b> | <b>5</b> | <b>6</b> | <b>7</b> | <b>8</b> | <b>9</b> |
|          |          |          |          |          |          |          |          |          |

AGORA DESENHE O QUE VOCÊ ENCONTROU.



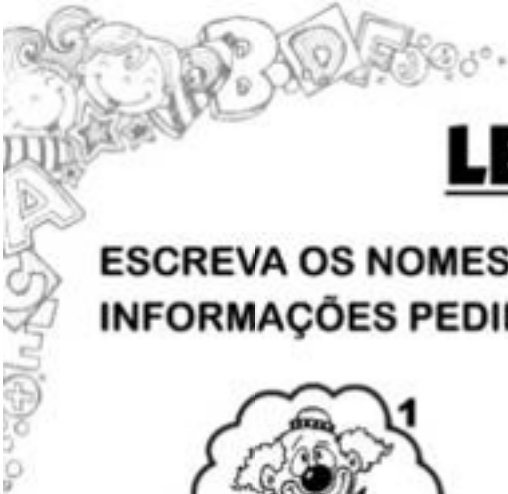

# LETRAS E SÍLABAS

ESCREVA OS NOMES DAS FIGURAS E COMPLETE A TABELA COM AS INFORMAÇÕES PEDIDAS.



| NOME | Nº DE LETRAS | Nº DE SÍLABAS |
|------|--------------|---------------|
| 1    |              |               |
| 2    |              |               |
| 3    |              |               |
| 4    |              |               |
| 5    |              |               |
| 6    |              |               |
| 7    |              |               |
| 8    |              |               |
| 9    |              |               |
| 10   |              |               |
| 11   |              |               |
| 12   |              |               |



# LISTA CONFUSA

ANGÉLICA ESTÁ TÃO ANSIOSA COM OS PREPARATIVOS PARA O SEU ANIVERSÁRIO QUE MISTUROU, NA MESMA LISTA, OS CONVIDADOS E O QUE PRECISA SER COMPRADO. AJUDE-A A SEPARAR TUDO ESCRREVENDO CADA PALAVRA NO SEU DEVIDO LUGAR.



## CONVIDADOS

---

---

---

---

---

---

---

---

---

---

---

---

---

---

---

---

---

---

---

---

---

---

---

---

## COMPRAS

---

---

---

---

---

---

---

---

---

---

---

---

---

---

---

---

---

---

---

---

---

---

---

---

BEATRIZ  
COPOS  
GUARDANAPOS  
AMANDA  
SHEILA  
BEXIGAS  
RICARDO

GARFINHOS  
IVÃ  
PRATINHOS  
VELA  
LUCIANA  
CAIO  
BALAS

JULIANO  
CHOCOLATE  
REFRIGERANTE  
DANIELA  
PÃO  
MARCELO  
PIPOCA



# CAÇA-PALAVRAS

CIRCULE NO DIAGRAMA O NOME DE CADA BRINQUEDO E ESCREVA-OS NOS LUGARES CORRESPONDENTES.

|   |   |   |   |   |   |   |   |   |   |   |   |   |   |
|---|---|---|---|---|---|---|---|---|---|---|---|---|---|
| F | M | O | U | Q | O | A | A | A | O | O | M | A |   |
| O | P | I | P | A | X | Q | B | X | U | X | P | A | D |
| L | C | U | Q | O | A | O | I | B | V | A | I | C | A |
| B | B | N | E | L | M | C | L | E | L | Ã | B | G |   |
| O | F | N | R | H | P | R | I | P | M | P | O | F | U |
| R | B | O | N | E | C | A | C | Ã | E | N | O | C | E |
| F | C | O | T | P | I | N | L | R | S | I | O | C | R |
| F | E | B | L | O | V | C | E | V | Q | V | B | E | A |
| A | D | V | S | D | N | N | T | L | D | N | V | D | L |
| M | L | N | U | V | J | C | A | J | S | J | N | L | M |
| P | A | T | I | N | E | T | E | O | P | V | Q | F | O |
| M | O | V | A | H | E | U | I | F | B | O | L | A | L |
| Ã | L | S | R | T | O | B | L | E | A | O | J | L | I |





# SIGA O MODELO

ESCREVA NOVAS PALAVRAS UTILIZANDO A ÚLTIMA LETRA DA PALAVRA ANTERIOR COMO PRIMEIRA LETRA DA PALAVRA SEGUINTE.



**EX: BANDEIRA**

**ARMÁRIO**



**TREM**



**PAPEL**



**SACI**



**ÓCULOS**



**JARDIM**



**COLAR**



**CAJU**



**PENTE**

# ESCREVA RÁPIDO

COMPLETE AS FICHAS O MAIS RÁPIDO POSSÍVEL DE ACORDO COM AS DICAS E DEPOIS COMPARE AS SUAS ESCOLHAS COM AS DOS COLEGAS. SÃO TRÊS TENTATIVAS POR FICHA E CADA PALAVRA CORRETA VALE 2 PONTOS. SE FOR REPETIDA, VALE UM.

FRUTA TERMINADA  
COM VOGAL



---

---

---

NOME DE ANIMAL



---

---

---

NOME PRÓPRIO FEMININO



---

---

---

PALAVRA DE 8 LETRAS



---

---

---

NOME DE COR INICIADO  
COM CONSOANTE



---

---

---

PALAVRA QUE CONTENHA  
A LETRA "H"



---

---

---

PALAVRA QUE CONTENHA  
A LETRA "G"



---

---

---

BRINQUEDO TERMINADO  
COM VOGAL



---

---

---

# PROFISSÕES

OBSERVE AS FIGURAS ABAIXO E CIRCULE O NOME DE CADA PROFISSIONAL.



**PESCADO**

**PESCA**

**PESCADOR**



**REMÉDIO**

**MÉDICO**

**MEDICINA**



**BOMBINHA**

**BOMBOM**

**BOMBEIRO**



**COZINHEIRO**

**COZINHA**

**COMPANHEIRO**



**PADEIRO**

**PEDREGULHO**

**PEDREIRO**



**MOTORISTA**

**MOTOR**

**MOTORIZADO**

# ENCAIXA-PALAVRAS

TODAS AS PALAVRAS QUE COMPLETAM O QUADRO SÃO ESCRITAS COM CINCO LETRAS. VEJA AS FIGURAS E ESCREVA OS NOMES DELAS NO LUGAR CERTO.

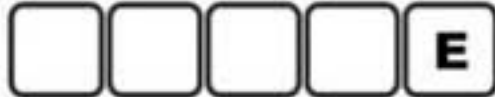

FOLHA  
SERROTE  
AVIÃO  
BALANÇO  
FUNIL  
CADEIRA

ÍNDIO  
PALHAÇO  
NINHO  
MAÇÃ  
PIMENTA

MAMÃO  
BALÃO  
CALÇA  
BANCO  
CAIXA

PEIXE  
VESTIDO  
POÇO  
MOEDA  
PENEIRA  
NOVELO



# CRUZADINHA

NUMERE AS PALAVRAS DA CRUZADINHA DE ACORDO COM AS INFORMAÇÕES.

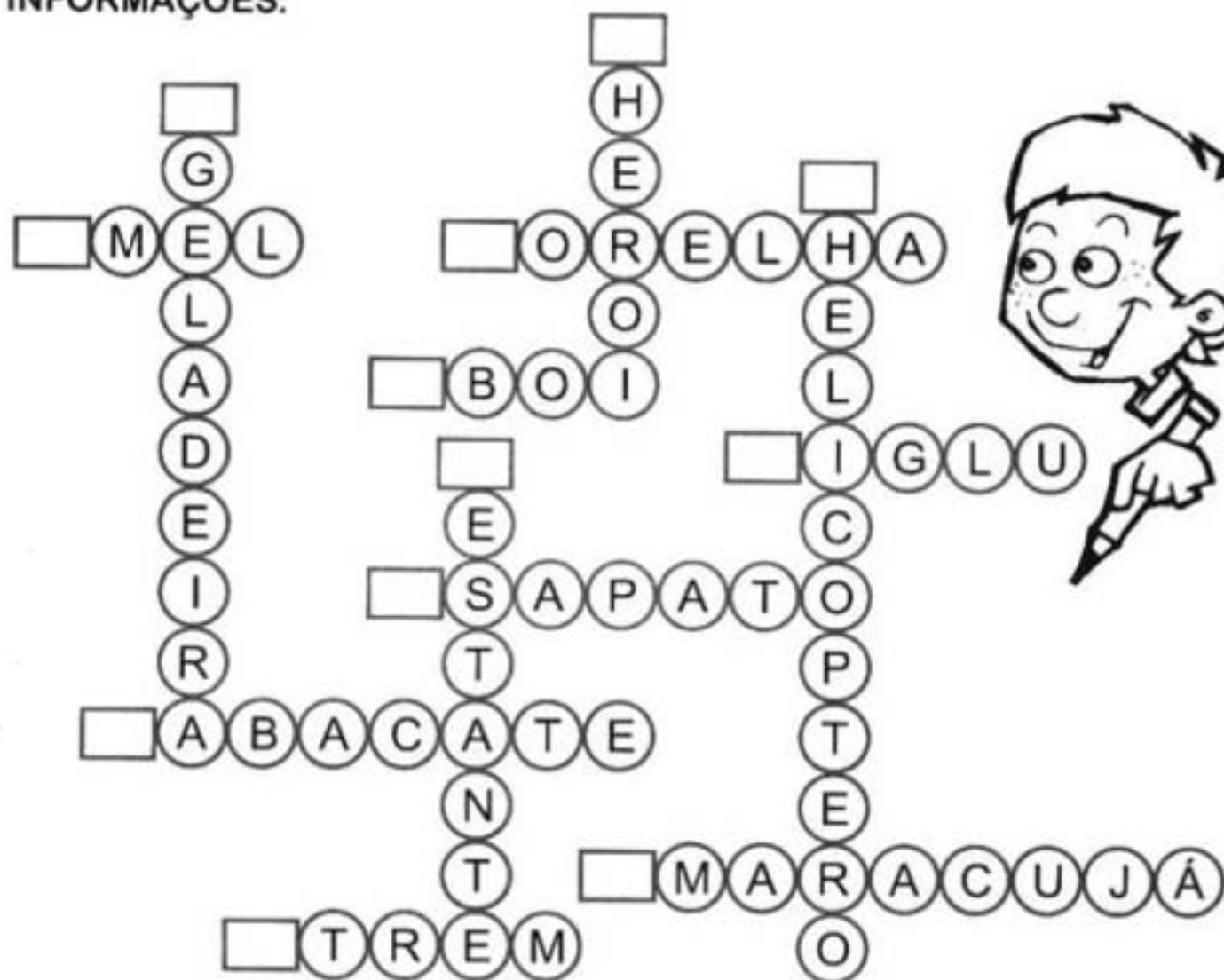

- 1 - NOME DE FRUTA INICIADO E TERMINADO EM VOGAL.
- 2 - PALAVRA INICIADA PELA 8ª LETRA DO ALFABETO E TERMINADA PELA 3ª VOGAL.
- 3 - PALAVRA DE 9 LETRAS, TERMINADA COM A.
- 4 - PALAVRA DE 3 LETRAS, SENDO 2 VOGAIS.
- 5 - PALAVRA DE 4 LETRAS, SENDO APENAS 1 VOGAL.
- 6 - PALAVRA DE 3 LETRAS, COM APENAS 1 VOGAL.
- 7 - NOME DE FRUTA COM 3 VOGAIS "A" E INICIADO COM CONSOANTE.
- 8 - NOME DE MÓVEL INICIADO E TERMINADO PELA 2ª VOGAL.
- 9 - PARTE DO CORPO INICIADA PELA 4ª VOGAL.
- 10 - PALAVRA DE 11 LETRAS, SENDO 6 CONSOANTES.
- 11 - PALAVRA COM 2 VOGAIS E 2 CONSOANTES.
- 12 - PALAVRA INICIADA COM A LETRA QUE VEM DEPOIS DO R.

# CRUZADINHA

COMPLETE A CRUZADINHA COM OS NOMES DAS FIGURAS.

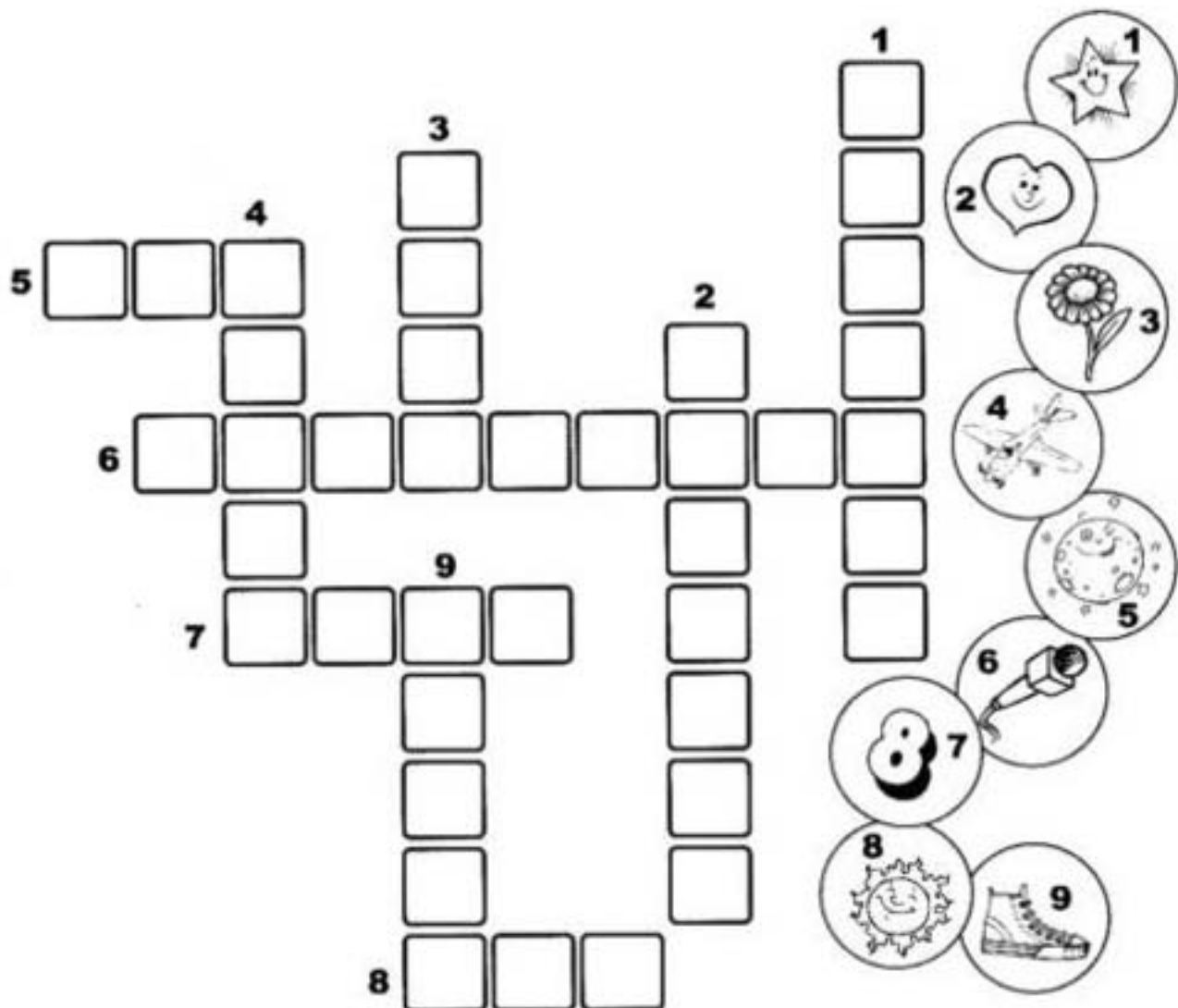

**RETIRE DA CRUZADINHA UMA PALAVRA ESCRITA COM:**

3 LETRAS, INICIADA E TERMINADA COM CONSOANTE.

9 LETRAS, INICIADA COM CONSOANTE E TERMINADA COM VOGAL.

4 LETRAS, COM APENAS 1 VOGAL.

4 LETRAS, COM APENAS 1 CONSOANTE.



# LIGUE-LIGUE

LIGUE CADA FIGURA ÀS LETRAS QUE FORMAM O SEU NOME. ESCREVA-NO NO ESPAÇO INDICADO.



Ó L I R O G E

---



U C E A C

---



E M A I

---



A S A T O P

---



S L O B A

---



L A Ç C A

---

# CRUZADINHA

COMPLETE A CRUZADINHA COM OS NOMES DAS FIGURAS.

## VERTICAIS



## HORIZONTAIS



BULE  
GARFO  
FACA  
FRIGIDEIRA  
JARRA  
PRATO  
COLHER  
FOGÃO  
MESA  
XÍCARA  
PANELA  
COPO  
GELADEIRA

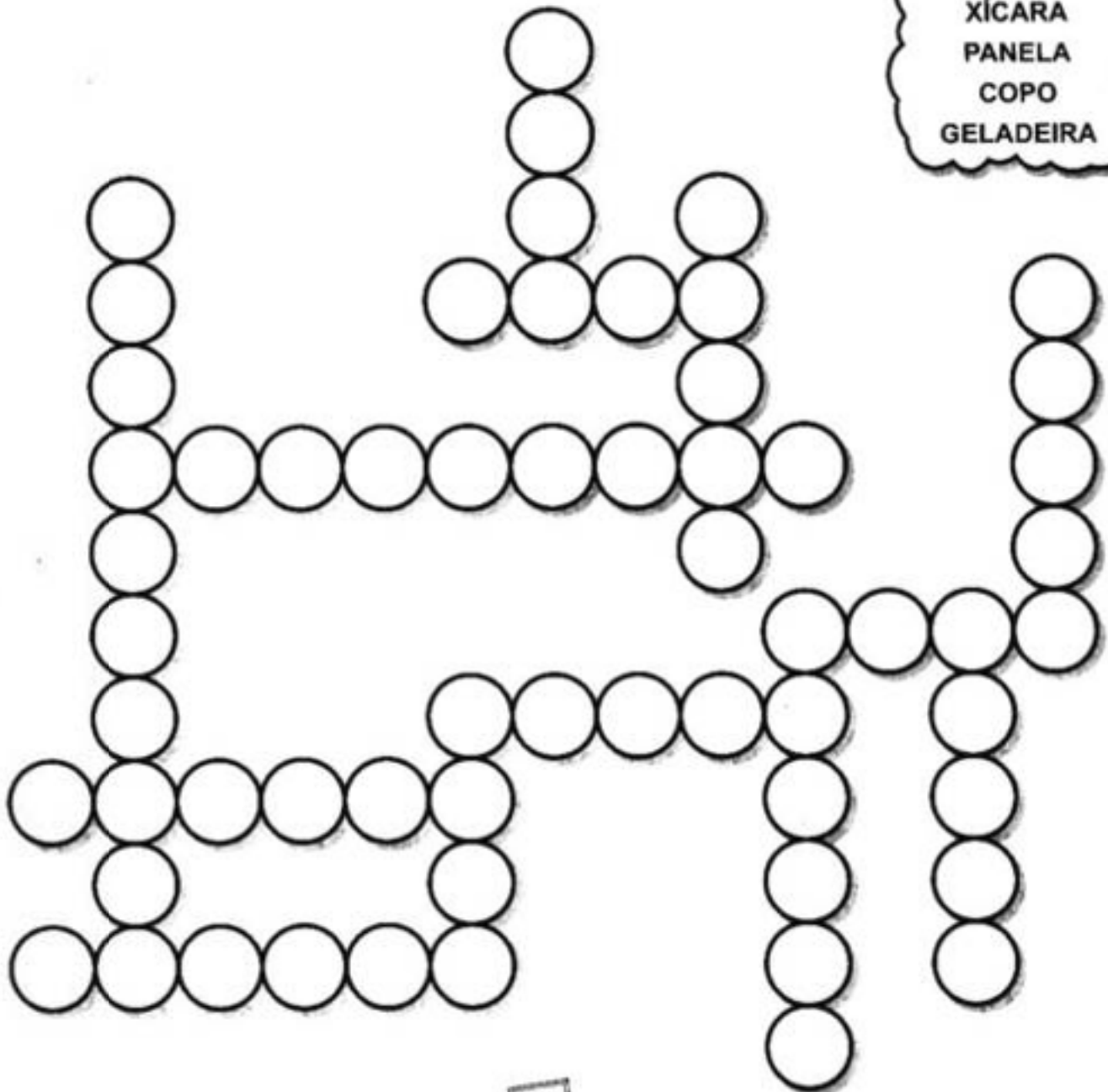



# LEITURA

LEIA CADA UMA DAS LISTAS E PINTE AS PALAVRAS QUE NÃO FAZEM PARTE DE CADA GRUPO.



## FRUTAS

MAMÃO PORTA  
PÊRA  
UNHA CAJU  
GOIABA BARCO  
MELANCIA  
RATO LARANJA

## BRINQUEDOS

FERRO TRENZINHO  
CARTA  
CORDA NINHO  
PETECA BOLA  
BONECA BELO  
CARRINHO

## NOME PRÓPRIO

TEREZA GATO  
MARIA MANOEL  
TIGRE MINHOCA  
AVIÃO  
JOAQUIM  
FLÁVIA VERA

## MÊS

JANEIRO FEVEREIRO  
GRAVATA MAIO  
DEZEMBRO PADRE  
JARRO AGOSTO  
RENATA ABRIL

## DIA DA SEMANA

JUNHO SÁBADO  
SEGUNDA-FEIRA  
NOVEMBRO DOMINGO  
OUTUBRO  
QUARTA-FEIRA  
TERÇA-FEIRA  
FEVEREIRO  
QUINTA-FEIRA

## ROUPAS

PRATO  
BLUSA JAQUETA  
CANETA  
HORTA  
CAMISETA MEIA  
CALÇA METRÔ  
CACHECOL

## MATERIAL ESCOLAR

OLHO LÁPIS  
BORRACHA  
FACA CANETA  
BRINCO  
ESTOJO LIVRO  
CADERNO ESTACA

## ANIMAL

TRIGO ELEFANTE  
LOUSA PORCO  
ARARA MANGUEIRA  
MORCEGO  
MILHO  
GALINHA TOURO

## FLOR

CRAVO BEIJO  
BETERRABA ROSA  
COPO-DE-LEITE  
LÍRIO BERRO  
PORTO MARGARIDA  
ORQUÍDEA



# CRUZADINHA

LEIA AS PALAVRAS E ESCREVA NA CRUZADINHA SOMENTE OS UTENSÍLIOS DOMÉSTICOS.

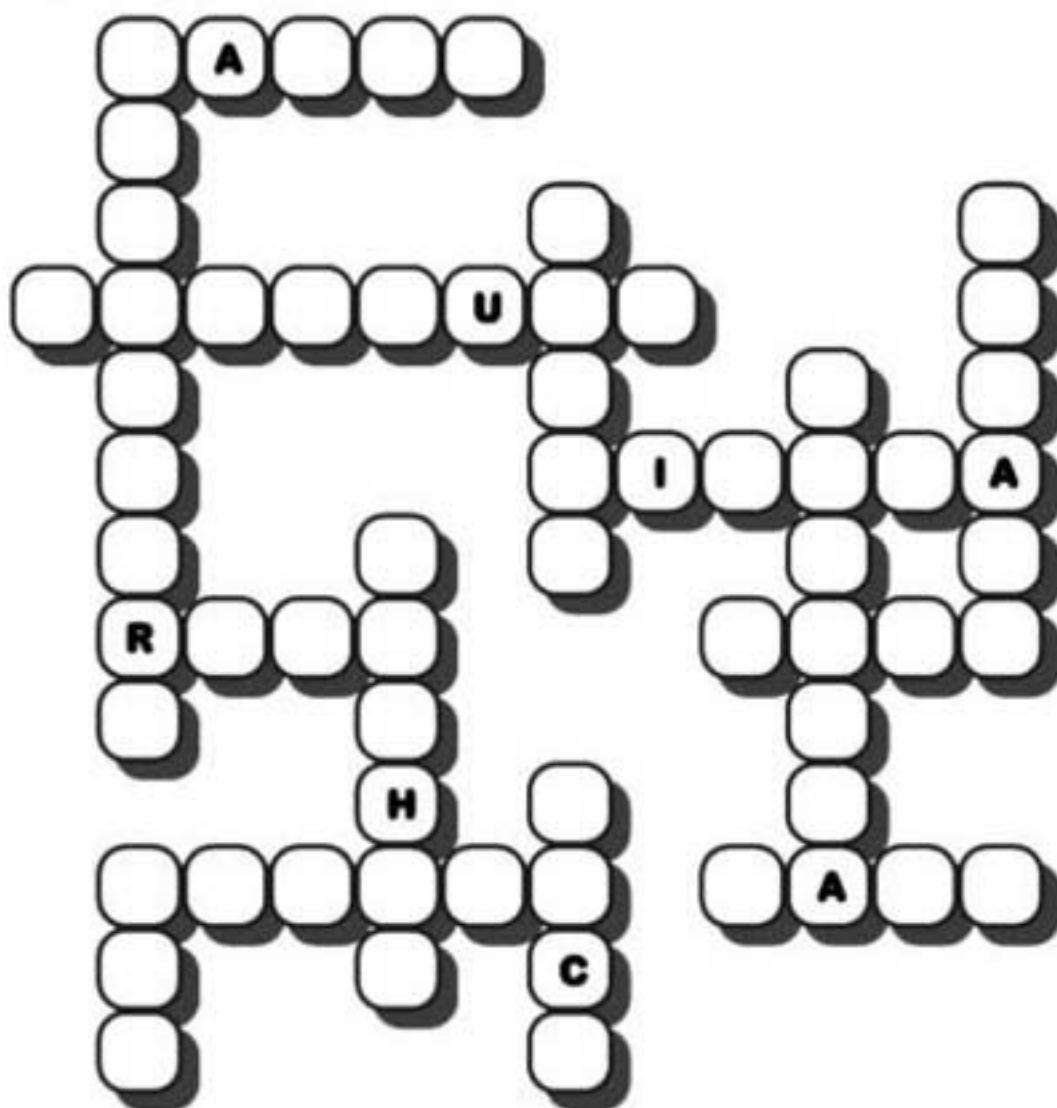

|   |   |   |   |
|---|---|---|---|
| <b>3 LETRAS</b><br>LUA<br>PIA<br>BOI<br>MÊS                 | <b>4 LETRAS</b><br>RODO<br>FACA<br>TAÇA<br>MESA                 | <b>5 LETRAS</b><br>TREZE<br>GARFO<br>VERSO<br>PRATO                 | <b>6 LETRAS</b><br>XÍCARA<br>TIGELA<br>COLHER<br>PANELA |
| <b>7 LETRAS</b><br>CHINESA<br>CACIQUE<br>VESTIDO<br>PENEIRA | <b>8 LETRAS</b><br>VASSOURA<br>BATIZADO<br>DEZEMBRO<br>CAMISETA | <b>9 LETRAS</b><br>GINÁSTICA<br>GELADEIRA<br>PORQUINHO<br>CASAMENTO |   |





# RECORTE E COLE

RECORTE E COLE AS PALAVRAS NO GRUPO A QUE PERTENCEM.

**MÓVEIS**

**FLORES**

**AVES**

**NENHUM DOS GRUPOS**

|  |  |  |  |
|--|--|--|--|
|  |  |  |  |
|--|--|--|--|

PRATO

CAMA

TELEFONE

CADERNO

CRAVO

ESTOJO



GIRASSOL

GAIVOTA

PAVÃO



JARDIM

MARGARIDA

GANSO

ABACAXI

MESA

ESTANTE

ROSA

BEIJA-FLOR

SOFÁ

CADEIRA

VIOLETA

ARMÁRIO

# CAÇA-PALAVRAS

CIRCULE NO DIAGRAMA OS NOMES DAS FIGURAS ABAIXO E ESCREVA-OS NOS LUGARES CORRESPONDENTES.



# ENCAIXA-NOMES

OBSERVE AS FIGURAS E ESCREVA OS NOMES DELAS NO LUGAR ADEQUADO.

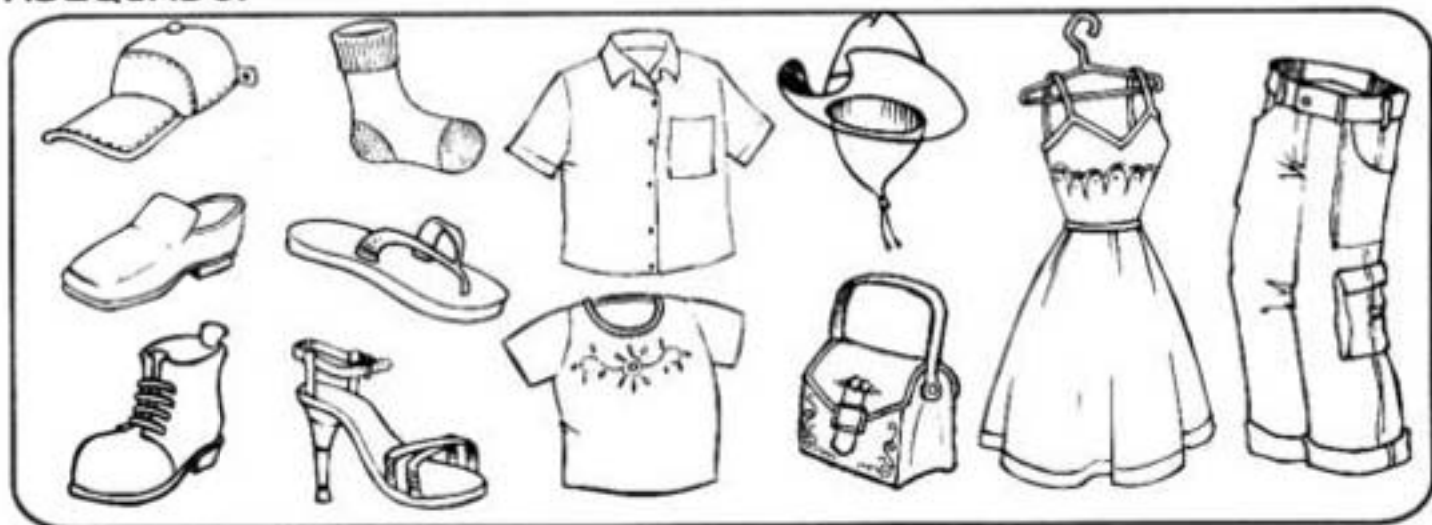

|   |   |   |   |   |   |   |   |
|---|---|---|---|---|---|---|---|
| □ | □ | □ | Ⓣ | □ | □ | □ |   |
| □ | □ | □ | □ | Ⓐ | □ | □ | □ |
| □ | Ⓞ | □ | □ | □ |   |   |   |
| □ | □ | □ | □ | Ⓢ | □ | □ | □ |
| □ | □ | Ⓛ | □ | □ |   |   |   |
| □ | Ⓐ | □ | □ | □ | □ |   |   |
| □ | Ⓞ | □ | □ |   |   |   |   |
| □ | Ⓔ | □ | □ |   |   |   |   |
| □ | □ | Ⓣ | □ |   |   |   |   |
| □ | □ | □ | □ | □ | Ⓤ |   |   |
| □ | □ | □ | □ | Ⓣ | □ |   |   |
| □ | □ | Ⓜ | □ | □ | □ | □ |   |

CAMISETA- CAMISA- BOTA- CHINELO- CALÇA- SANDÁLIA-  
SAPATO- BOLSA- CHAPÉU- BONÉ- VESTIDO- MEIA



# UNIVERSO DE PALAVRAS

ESCREVA O MÁXIMO DE PALAVRAS QUE CONSEGUIR UTILIZANDO AS LETRAS ABAIXO.

A large rectangular area with two columns of horizontal lines for writing. On the right side, there is a cartoon pencil character with a face, arms, and legs, appearing to be writing on the lines. The pencil has a smiling face and is holding a small piece of paper.

# EXPLORANDO O UNIVERSO

RESPONDA AS QUESTÕES ABAIXO UTILIZANDO AS PALAVRAS QUE VOCÊ ESCREVEU.



QUAL FOI A MAIOR PALAVRA QUE VOCÊ ESCREVEU?

---

E A MENOR? COMO VOCÊ SABE?

---

---

VOCÊ ESCREVEU PALAVRAS INICIADAS COM VOGAIS? QUAIS?

---

VOCÊ ESCREVEU PALAVRAS INICIADAS COM CONSOANTES? QUAIS?

---

VOCÊ ESCREVEU PALAVRAS SEM REPETIR LETRAS? QUAIS?

---

VOCÊ ESCREVEU PALAVRAS COM MAIS DE 6 LETRAS? QUAIS?

---

É POSSÍVEL ESCREVER A PALAVRA IMPOSSÍVEL? POR QUÊ?

---

É POSSÍVEL ESCREVER A PALAVRA SURPRESA? POR QUÊ?

---



# MEXE-MEXE FECHADO

ESCREVA OS NOMES DOS MATERIAIS ESCOLARES ABAIXO USANDO AS LETRAS DO QUADRO. ATENÇÃO, POIS NÃO PODE SOBRRAR NENHUMA.



|  |  |  |  |  |  |
|--|--|--|--|--|--|
|  |  |  |  |  |  |
|--|--|--|--|--|--|



|  |  |  |  |  |  |  |
|--|--|--|--|--|--|--|
|  |  |  |  |  |  |  |
|--|--|--|--|--|--|--|



|  |  |  |  |  |  |  |  |  |
|--|--|--|--|--|--|--|--|--|
|  |  |  |  |  |  |  |  |  |
|--|--|--|--|--|--|--|--|--|



|  |  |  |  |
|--|--|--|--|
|  |  |  |  |
|--|--|--|--|



|  |  |  |  |  |  |  |
|--|--|--|--|--|--|--|
|  |  |  |  |  |  |  |
|--|--|--|--|--|--|--|



|  |  |  |  |  |  |  |
|--|--|--|--|--|--|--|
|  |  |  |  |  |  |  |
|--|--|--|--|--|--|--|

|          |          |          |          |          |          |          |          |          |          |
|----------|----------|----------|----------|----------|----------|----------|----------|----------|----------|
| <b>A</b> | <b>D</b> | <b>A</b> | <b>T</b> | <b>U</b> | <b>O</b> | <b>E</b> | <b>O</b> | <b>A</b> | <b>H</b> |
| <b>L</b> | <b>A</b> | <b>E</b> | <b>N</b> | <b>A</b> | <b>O</b> | <b>T</b> | <b>D</b> | <b>A</b> | <b>C</b> |
| <b>S</b> | <b>T</b> | <b>R</b> | <b>A</b> | <b>C</b> | <b>N</b> | <b>C</b> | <b>O</b> | <b>I</b> |          |
| <b>N</b> | <b>O</b> | <b>M</b> | <b>C</b> | <b>O</b> | <b>P</b> | <b>R</b> | <b>R</b> | <b>E</b> | <b>L</b> |

# BRINCANDO COM AS LETRAS

ORGANIZE AS LETRAS E ESCREVA OS NOMES DESTAS PROFISSÕES.



\_\_\_\_\_



\_\_\_\_\_



\_\_\_\_\_



\_\_\_\_\_



\_\_\_\_\_



\_\_\_\_\_



\_\_\_\_\_



\_\_\_\_\_

# RECORTE E COLE

LEIA AS DICAS, DEPOIS RECORTE E COLE AS PALAVRAS NO LUGAR CORRESPONDENTE.

**CONJUNTO DE 30 OU 31 DIAS**



**OITAVO MÊS DO ANO**

**OBJETO USADO PARA APOIAR  
A XÍCARA**



**ENFEITE USADO PARA  
ESCONDER O ROSTO EM FESTAS**

**NELE GUARDAMOS LÁPIS,  
BORRACHA, CANETA...**



**CALÇADO USADO PARA A  
PRÁTICA ESPORTIVA**

**PIRES**

**AGOSTO**

**ESTOJO**

**MÁSCARA**

**TÊNIS**

**MÊS**

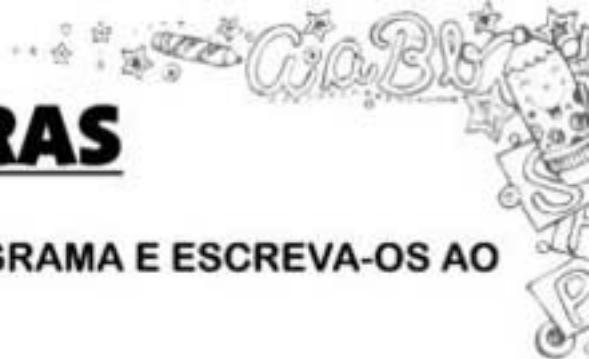

# CAÇA-PALAVRAS

ENCONTRE OS NOMES DAS FIGURAS NO DIAGRAMA E ESCREVA-OS AO LADO DE CADA UMA.



\_\_\_\_\_



\_\_\_\_\_



\_\_\_\_\_



\_\_\_\_\_



\_\_\_\_\_



\_\_\_\_\_



\_\_\_\_\_



\_\_\_\_\_



\_\_\_\_\_



\_\_\_\_\_

|   |   |   |   |   |   |   |   |   |   |   |   |   |   |   |   |
|---|---|---|---|---|---|---|---|---|---|---|---|---|---|---|---|
| D | R | A | G | Ã | O | E | F | R | E | O | T | F | U | O | C |
| B | E | P | I | C | O | C | I | L | A | R | U | O | G | J | O |
| R | O | A | T | K | G | A | L | U | F | T | P | X | A | N | N |
| I | D | N | B | O | R | F | H | N | E | S | R | T | T | G | S |
| C | O | A | N | L | A | O | P | H | G | A | A | Q | R | S | O |
| I | Z | N | G | I | F | I | O | A | F | P | T | T | A | L | E |
| B | F | A | V | V | T | B | N | B | Y | O | O | S | V | K | S |
| L | T | E | C | R | A | V | O | A | F | T | A | L | E | P | T |
| O | I | E | V | O | B | D | F | D | L | I | D | P | S | S | R |
| D | G | H | C | E | R | B | R | U | X | A | L | A | S | E | E |
| E | R | A | G | R | A | M | E | T | O | U | S | D | E | H | L |
| P | E | G | T | R | H | F | B | Y | A | C | M | C | I | N | A |
| O | P | T | A | J | S | C | R | P | T | I | I | T | R | G | D |
| P | R | I | N | C | E | S | A | C | O | A | R | D | O | A | G |
| B | G | D | B | V | X | F | T | U | E | H | D | A | P | U | O |
| U | X | A | D | R | E | Z | P | A | B | D | O | F | T | B | R |



# FIQUE DE OLHO

SOMENTE SETE FIGURAS DO QUADRO TERMINAM COM A MESMA LETRA.  
DESCUBRA QUAIS SÃO E ESCREVA OS NOMES DELAS.

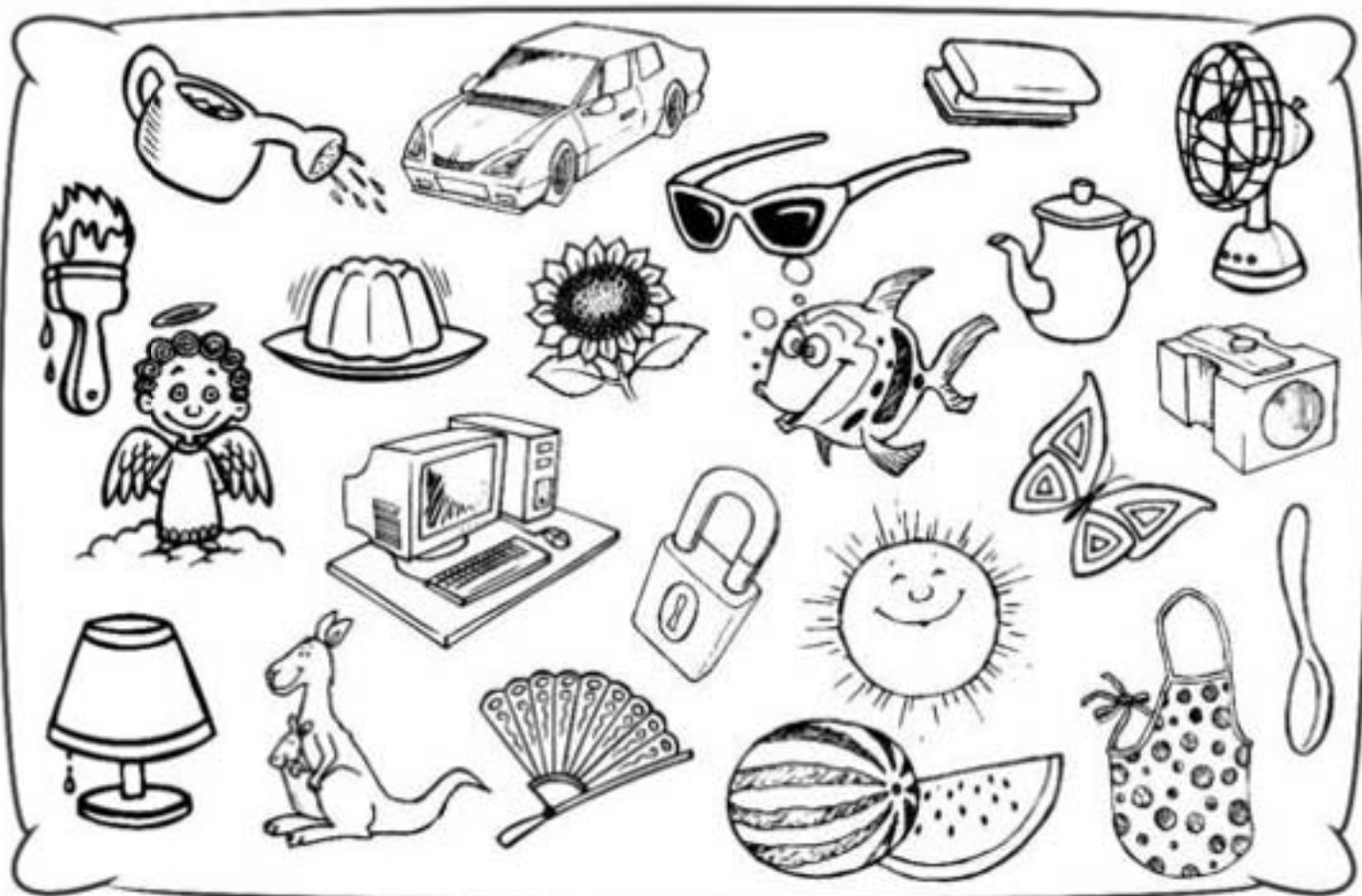

---

---

---

---

---

---

---

---



# CAÇA-PALAVRAS

CIRCULE NO DIAGRAMA OS NOMES DAS FIGURAS E ESCREVA-OS FORMANDO DOIS GRUPOS, DE ACORDO COM O QUE ELES TÊM EM COMUM. DEPOIS EXPLIQUE PARA OS COLEGAS COMO VOCÊ PENSOU PARA AGRUPÁ-LOS.



|   |   |   |   |   |   |   |   |   |   |   |   |
|---|---|---|---|---|---|---|---|---|---|---|---|
| E | S | V | R | O | E | N | S | E | R | P | O |
| N | G | I | R | A | F | A | N | O | E | G | L |
| G | L | R | M | F | G | R | L | I | G | A | F |
| R | F | B | O | E | R | N | F | B | N | R | E |
| C | J | O | A | N | I | N | H | A | P | F | M |
| A | B | L | F | J | N | Z | F | S | D | O | Z |
| J | A | N | E | L | A | N | B | F | V | G | N |
| U | D | D | F | O | O | G | J | B | N | F | A |
| P | A | E | R | E | L | O | G | I | O | G | N |
| J | L | G | N | J | S | D | B | F | V | P | J |
| R | M | O | R | A | N | G | O | L | Q | T | O |
| N | A | U | G | E | N | G | J | B | N | F | G |





# CRUZADINHA

COMPLETE A CRUZADINHA COM OS NOMES DAS FIGURAS QUE TÊM A MESMA LETRA INICIAL.

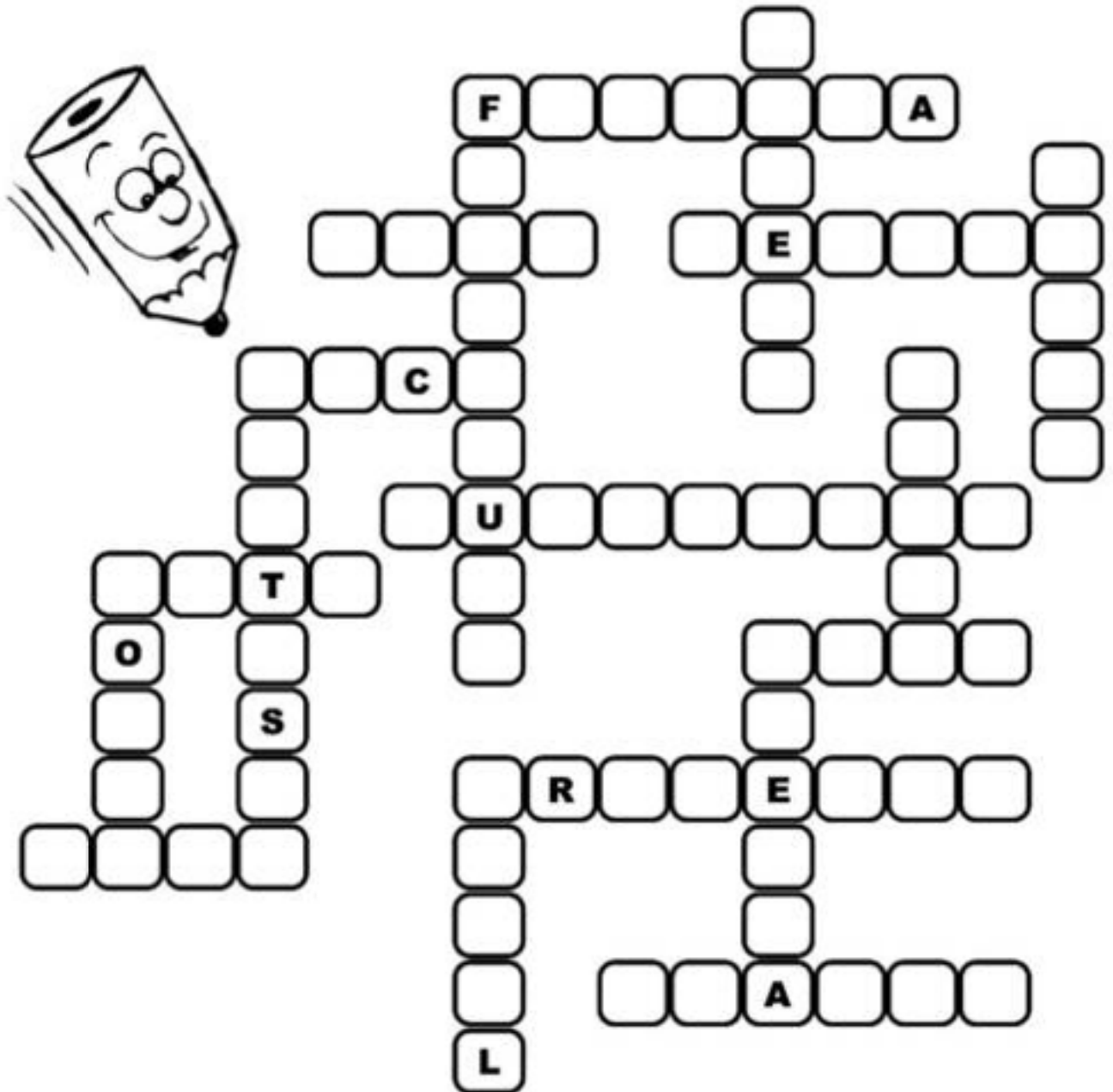

# TRABALHANDO A CRUZADINHA

PENSANDO NA CRUZADINHA DA PÁGINA ANTERIOR, RESPONDA AS QUESTÕES ABAIXO. CONSULTE O BANCO DE PALAVRAS SE PRECISAR.

FACA  
FOCA  
FLOR  
FADA  
FITA



LETRAS

FERRO  
FUNIL  
FOLHA  
PEIXE  
BERCO  
FOGÃO



LETRAS

CHAPÉU  
FIVELA  
FLECHA  
FEIJÃO  
JACARÉ  
FLAUTA  
ÁRVORE



LETRAS

VIOLINO  
RELÓGIO  
VESTIDO  
ABACATE  
FORMIGA  
MORANGO



LETRAS

FRUTEIRA  
CAMINHÃO  
FANTASMA



LETRAS

FECHADURA  
FURADEIRA



LETRAS

QUAL A LETRA INICIAL DAS PALAVRAS ESCRITAS NA CRUZADINHA?

ESCREVA-AS AGORA, EM ORDEM ALFABÉTICA.



# CAÇA-PALAVRAS

ENCONTRE NO DIAGRAMA OS NOMES DAS FIGURAS ABAIXO. ESCREVA-O JUNTO A CADA UMA.



\_\_\_\_\_



\_\_\_\_\_



\_\_\_\_\_



\_\_\_\_\_



\_\_\_\_\_



\_\_\_\_\_



\_\_\_\_\_



\_\_\_\_\_



\_\_\_\_\_



\_\_\_\_\_

ONLOCTCONCHATYXONN  
NHIDA OOR GUNESCTIGH  
CTPKCNC AOLHG AHQAST  
EOECHINELORFPUTBLO  
TNSFOVGTANBYOPSAKM  
LASGRTCHUCHUTELHPA  
OGEJRVCBH HDLITFTST  
POGXOCEREAACZAAOCE  
TIO TNOIU PVLHUSANHI  
NNPDGTRHFEYACGCAUT  
CHALEIRACRPPITNNVA  
AFHLGUAOJÇUEARBGEF  
UFSGDBVXF TUUHDOPIF  
BRCACHIMBOANGOPTRR  
ARMOHXIULGPDZSTOOR

# TRAVA-LÍNGUAS

TROQUE O SÍMBOLO PELA LETRA E ESCREVA ESTE TRAVA-LÍNGUA.

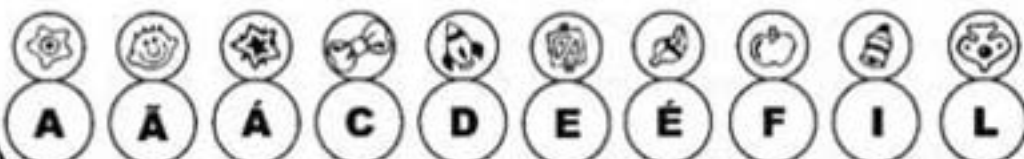

# VOCÊ SABIA?

CHÁ É UMA BEBIDA FEITA COM FOLHAS DE ALGUNS TIPOS DE PLANTAS. SEU PREPARO É FEITO COLOCANDO-SE AS FOLHAS OU AS FLORES, FRESCAS OU SECAS, EM ÁGUA FERVENTE.

ALGUMAS PLANTAS USADAS PARA O PREPARO DESTA BEBIDA TÊM PROPRIEDADES MEDICINAIS E O USO DO CHÁ, NESTES CASOS, É COMO UM REMÉDIO.

VEJA ALGUMAS PLANTAS QUE SÃO USADAS PARA FAZER CHÁ E QUE SÃO CONSIDERADAS DE USO MEDICINAL:

- ROMÃ;
- ALFAZEMA;
- CAMOMILA;
- ERVA-CIDREIRA;
- BOLDO-DO-CHILE;
- HORTELÃ.

AGORA PENSE E DEPOIS RESPONDA:

ESTE TEXTO É:

- RECEITA
- POESIA
- INFORMATIVO
- CONTO DE FADAS



JUSTIFIQUE SUA RESPOSTA.

---

---

---

---

---

---

---

---

# SÍLABAS

A PALAVRA "CHÁ" TEM APENAS UMA SÍLABA E, POR ISSO, É CHAMADA "MONOSSÍLABA". PESQUISE, RECORTE E COLE PALAVRAS MONOSSÍLABAS.





# VAMOS LER?

LEIA O TEXTO E ESCREVA O QUE SE PEDE.

## PEIXE VIVO

COMO PODE O PEIXE VIVO  
VIVER FORA DA ÁGUA FRIA  
COMO PODE O PEIXE VIVO  
VIVER FORA DA ÁGUA FRIA

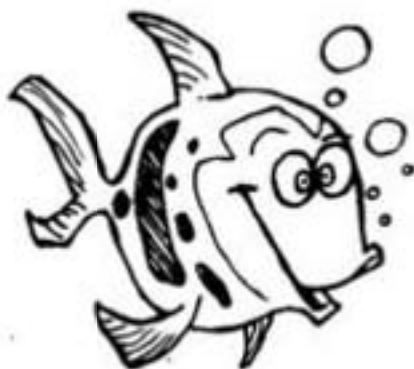

COMO PODEREI VIVER  
COMO PODEREI VIVER  
SEM A TUA, SEM A TUA  
SEM A TUA COMPANHIA  
SEM A TUA, SEM A TUA  
SEM A TUA COMPANHIA

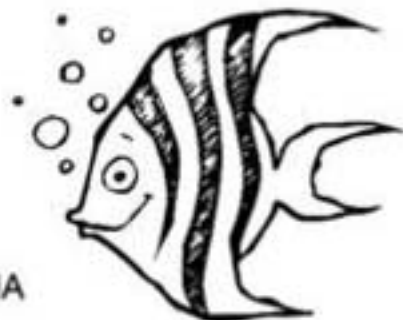

OS PASTORES DESTA ALDEIA  
JÁ ME FAZEM ZOMBARIA  
OS PASTORES DESTA ALDEIA  
JÁ ME FAZEM ZOMBARIA

POR ME VEREM ASSIM CHORANDO  
POR ME VEREM ASSIM CHORANDO  
SEM A TUA, SEM A TUA  
SEM A TUA COMPANHIA  
SEM A TUA, SEM A TUA  
SEM A TUA COMPANHIA

QUAL A PALAVRA QUE APARECE MAIS VEZES NO TEXTO? QUANTAS VEZES?

---

---

QUANTAS LETRAS TEM ESTA PALAVRA? E QUANTAS SÍLABAS?

---

ESCREVA AS PALAVRAS MONOSSÍLABAS QUE APARECEM NO TEXTO.

---

---

---



# PARA SABER MAIS

LEIA O TEXTO ABAIXO COM ATENÇÃO.

SABE DE TUDO,  
MAS NÃO FALA NADA.  
JÁ SABE O QUE É?



ESCREVA A PRIMEIRA LETRA DE CADA FIGURA E SAIBA A RESPOSTA.



\_\_\_\_\_

\_\_\_\_\_

\_\_\_\_\_

\_\_\_\_\_

\_\_\_\_\_

O TEXTO QUE VOCÊ LEU É:

POESIA

MÚSICA

ADIVINHA

INFORMATIVO

JUSTIFIQUE SUA RESPOSTA.

---

---

---

---

---

---

---

---

---

---



# CAÇA-PALAVRAS

A PALAVRA "LIVRO" TEM DUAS SÍLABAS E, POR ISSO, É CHAMADA "DISSÍLABA". ENCONTRE NO DIAGRAMA OS NOMES DAS FIGURAS E ESCREVA-OS AO LADO DE CADA UMA, SEPARANDO AS SÍLABAS DAS PALAVRAS.



\_\_\_\_\_



\_\_\_\_\_



\_\_\_\_\_



\_\_\_\_\_



\_\_\_\_\_



\_\_\_\_\_



\_\_\_\_\_



\_\_\_\_\_



\_\_\_\_\_



\_\_\_\_\_



\_\_\_\_\_



\_\_\_\_\_



\_\_\_\_\_



\_\_\_\_\_



\_\_\_\_\_

# CRUZADINHA

GRIFE NO TEXTO E ESCREVA NA CRUZADINHA AS PALAVRAS DISSÍLABAS QUE APARECEM NESTA CANTIGA.

## SAPO CURURU

SAPO CURURU  
NA BEIRA DO RIO  
QUANDO O SAPO GRITA, Ó MANINHA,  
DIZ QUE ESTÁ COM FRIO.  
A MULHER DO SAPO,  
É QUEM ESTÁ LÁ DENTRO  
FAZENDO RENDINHA, Ó MANINHA,  
PRO SEU CASAMENTO.

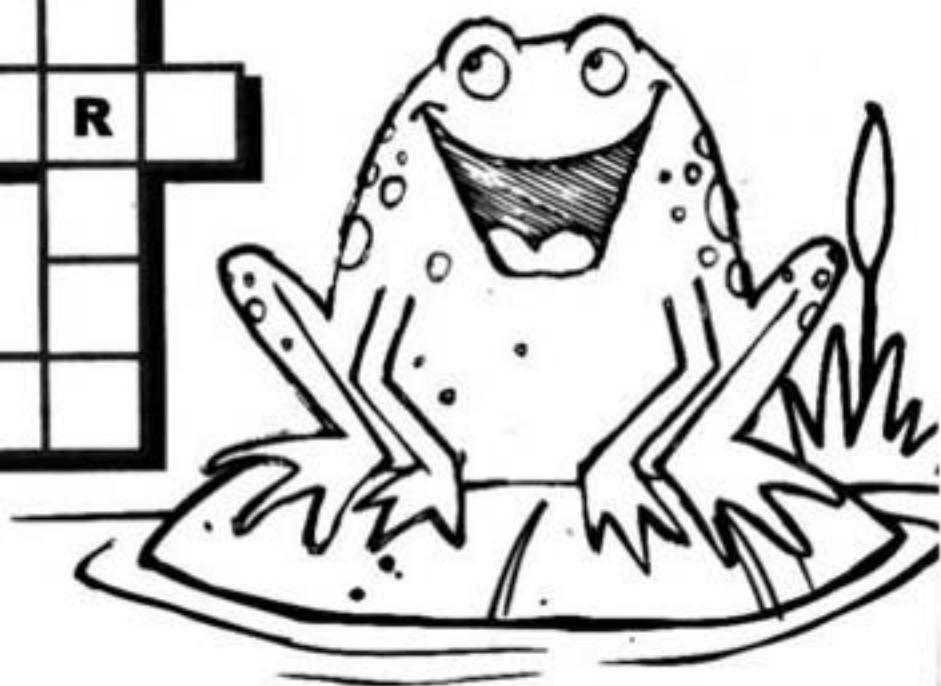

# PINTA-PONTOS

PINTE SOMENTE OS ESPAÇOS QUE CONTÊM SÍLABAS DE DUAS LETRAS E TENHA UMA SURPRESA.

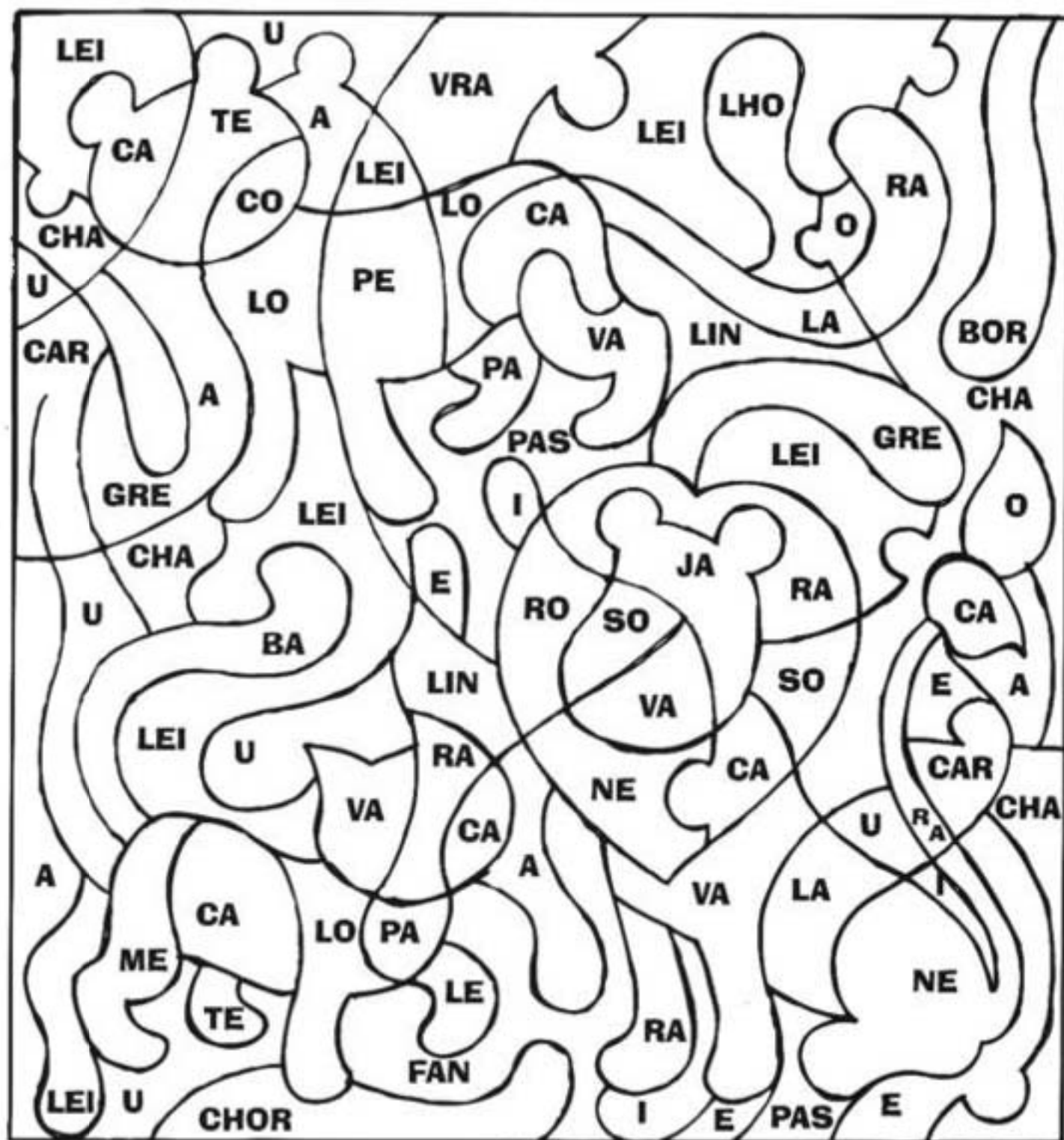

O QUE VOCÊ ENCONTROU? O QUE OS NOMES DELES TÊM EM COMUM?

---

---

# PINTA-PONTOS

PINTE OS PONTOS MARCADOS COM CONSOANTES E DESCUBRA QUAL É A FIGURA.



O QUE VOCÊ ENCONTROU? FALE O QUE SABE SOBRE ESTA FIGURA.

---

---

---

---

---

---

---

---

---

---

# SÍLABAS

AS PALAVRAS ESCRITAS COM TRÊS SÍLABAS SÃO CHAMADAS DE "TRISSÍLABAS". USANDO A SÍLABA DE CADA QUADRO, ESCREVA TRÊS PALAVRAS TRISSÍLABAS EM QUE ESTA SÍLABA APAREÇA NO COMEÇO, NO MEIO OU NO FIM DE CADA UMA. VEJA O EXEMPLO.



COQUEIRO  
ESCOLA  
MACACO



\_\_\_\_\_  
\_\_\_\_\_  
\_\_\_\_\_



\_\_\_\_\_  
\_\_\_\_\_  
\_\_\_\_\_



\_\_\_\_\_  
\_\_\_\_\_  
\_\_\_\_\_



\_\_\_\_\_  
\_\_\_\_\_  
\_\_\_\_\_



\_\_\_\_\_  
\_\_\_\_\_  
\_\_\_\_\_



\_\_\_\_\_  
\_\_\_\_\_  
\_\_\_\_\_



\_\_\_\_\_  
\_\_\_\_\_  
\_\_\_\_\_

# TRISSÍLABAS

DOS ANIMAIS ABAIXO, APENAS ESCREVA O NOME DOS QUE TÊM TRÊS SÍLABAS.

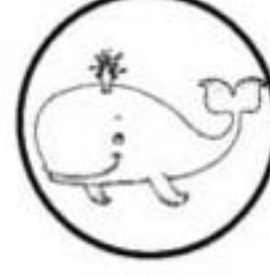
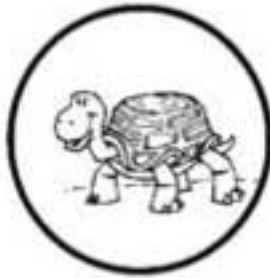

---

---

---

---

---

---

---

---



# **CRUZADINHA**

**COMPLETE A CRUZADINHA USANDO SOMENTE OS NOMES DAS FIGURAS QUE POSSUEM TRÊS SÍLABAS.**

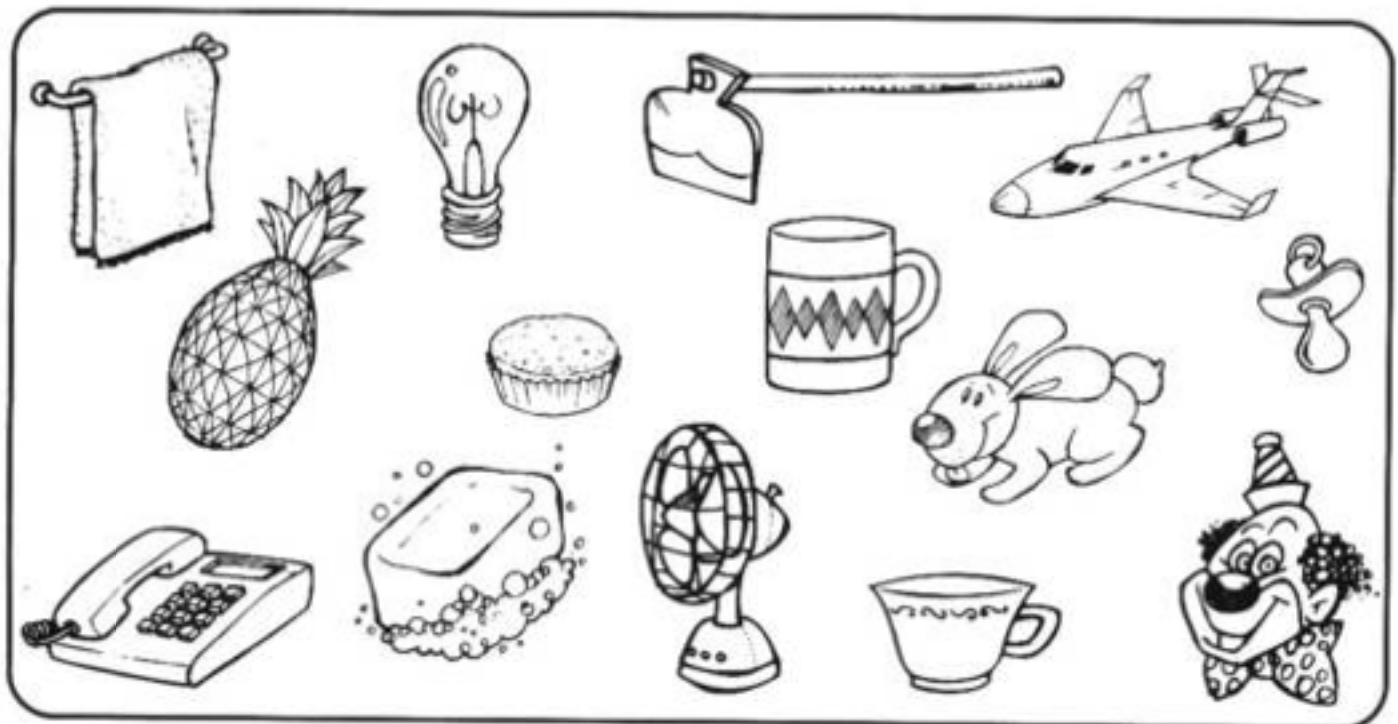

|  |  |          |          |  |  |          |  |  |  |  |  |  |
|--|--|----------|----------|--|--|----------|--|--|--|--|--|--|
|  |  |          | <b>C</b> |  |  |          |  |  |  |  |  |  |
|  |  |          |          |  |  |          |  |  |  |  |  |  |
|  |  |          |          |  |  |          |  |  |  |  |  |  |
|  |  |          | <b>E</b> |  |  |          |  |  |  |  |  |  |
|  |  | <b>M</b> |          |  |  |          |  |  |  |  |  |  |
|  |  |          |          |  |  | <b>C</b> |  |  |  |  |  |  |
|  |  |          |          |  |  |          |  |  |  |  |  |  |
|  |  |          |          |  |  |          |  |  |  |  |  |  |
|  |  |          |          |  |  |          |  |  |  |  |  |  |
|  |  |          |          |  |  |          |  |  |  |  |  |  |

- ABACAXI**
- TELEFONE**
- SABONETE**
- VENTILADOR**
- TOALHA**
- EMPADA**
- LÂMPADA**
- AVIÃO**
- COELHO**
- PALHAÇO**
- ENXADA**
- CHUPETA**
- XÍCARA**
- CANECA**

# FIQUE DE OLHO

SOMENTE OITO FIGURAS SÃO ESCRITAS COM TRÊS SÍLABAS. DESCUBRA  
QUAIS SÃO E ESCREVA-AS NOS ESPAÇOS ABAIXO.

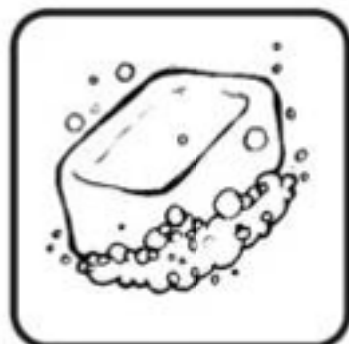

|  |
|--|
|  |
|  |
|  |
|  |

|  |
|--|
|  |
|  |
|  |
|  |



# CAÇA-PALAVRAS

ENCONTRE NO DIAGRAMA OS NOMES DE DEZ FRUTAS TRISSÍLABAS.  
DEPOIS, ESCREVA-OS NAS LINHAS ABAIXO.



|   |   |   |   |   |   |   |   |   |   |   |   |   |   |   |   |
|---|---|---|---|---|---|---|---|---|---|---|---|---|---|---|---|
| J | R | S | A | D | A | C | R | R | E | O | G | F | U | O | E |
| E | A | B | T | R | M | D | B | V | F | W | Q | O | G | J | F |
| L | O | A | T | K | O | S | H | U | F | T | Y | X | O | N | N |
| I | D | N | O | O | R | G | U | N | E | S | C | T | I | G | H |
| P | K | A | N | C | A | O | L | H | G | A | P | Q | A | S | T |
| E | Z | N | G | O | F | P | O | R | F | P | E | T | B | L | O |
| S | F | A | V | G | T | A | N | B | Y | O | J | S | A | K | M |
| S | G | U | T | D | U | N | R | T | F | T | A | L | H | P | A |
| E | J | E | V | C | B | H | F | D | L | I | D | F | T | S | T |
| G | X | H | C | E | R | E | J | A | D | Z | L | A | O | E | E |
| O | T | N | O | I | U | P | V | L | A | U | S | A | N | H | I |
| P | D | G | T | R | H | F | B | Y | A | C | G | C | A | N | T |
| O | P | T | A | J | S | C | R | P | P | I | T | A | N | G | A |
| H | L | A | R | A | N | J | A | B | U | A | R | E | G | A | F |
| S | G | D | B | V | X | F | T | U | E | H | D | A | P | U | F |
| U | B | E | V | C | M | O | R | A | N | G | O | F | T | B | R |
| P | M | H | D | I | U | L | G | P | D | Z | Ç | Ã | O | E | R |



|       |       |
|-------|-------|
| _____ | _____ |
| _____ | _____ |
| _____ | _____ |
| _____ | _____ |
| _____ | _____ |

# ENCAIXA-SÍLABAS

ESCREVA OS NOMES DAS FIGURAS USANDO UM QUADRINHO PARA CADA SÍLABA DA PALAVRA. PINTE OS QUE VOCÊ NÃO PRECISAR USAR.

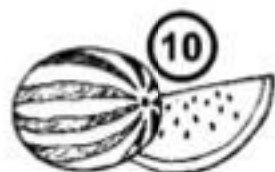

10



8



16



2



14



7

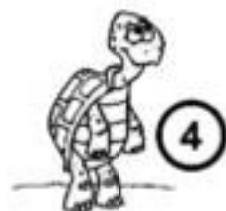

4



11

|    |  |  |  |  |  |
|----|--|--|--|--|--|
| 1  |  |  |  |  |  |
| 2  |  |  |  |  |  |
| 3  |  |  |  |  |  |
| 4  |  |  |  |  |  |
| 5  |  |  |  |  |  |
| 6  |  |  |  |  |  |
| 7  |  |  |  |  |  |
| 8  |  |  |  |  |  |
| 9  |  |  |  |  |  |
| 10 |  |  |  |  |  |
| 11 |  |  |  |  |  |
| 12 |  |  |  |  |  |
| 13 |  |  |  |  |  |
| 14 |  |  |  |  |  |
| 15 |  |  |  |  |  |
| 16 |  |  |  |  |  |
| 17 |  |  |  |  |  |
| 18 |  |  |  |  |  |



6



17



3



15



13



5



18



1



12



9

# SÍLABAS

ANALISE A ATIVIDADE DA PÁGINA ANTERIOR E RESPONDA:

COM QUANTAS SÍLABAS ERAM ESCRITAS AQUELAS PALAVRAS?

- UMA SÍLABA.
- DUAS SÍLABAS.
- TRÊS SÍLABAS.
- QUATRO OU MAIS SÍLABAS.



ORGANIZE AS PALAVRAS NA ORDEM CORRETA E LEIA A INFORMAÇÃO.

|         |               |     |        |          |          |
|---------|---------------|-----|--------|----------|----------|
| 6       | 11            | 4   | 5      | 2        | 3        |
| SÍLABAS | DE            | COM | QUATRO | PALAVRAS | ESCRITAS |
| 9       | 12            | 1   | 7      | 8        | 10       |
| SÃO     | POLISSÍLABAS. | AS  | OU     | MAIS     | CHAMADAS |

---

---

---

---

---

RECORTE E COLE DE JORNAIS OU REVISTAS TRÊS PALAVRAS POLISSÍLABAS.



# POLISSÍLABAS

ESCREVA A RESPOSTA DE CADA QUESTÃO SEPARANDO AS SÍLABAS DELAS.

- 1- LUGAR ONDE MORAM AS FORMIGAS.
- 2- DIMINUTIVO DE "AMIGO".
- 3- ÁRVORE EM QUE NASCE O PÊSSEGO.
- 4- VEÍCULO USADO NO TRANSPORTE DE DOENTES.
- 5- CONJUNTO DE LETRAS.
- 6- A FADA MADRINHA TRANSFORMOU UMA ABÓBORA NESTE TRANSPORTE.
- 7- SEGUNDO MÊS DO ANO.
- 8- NELA COLOCAMOS A CHAVE PARA ABRIR UMA PORTA.
- 9- OBJETO MACIO USADO PARA APOIAR A CABEÇA QUANDO DORMIMOS.
- 10- MEIO DE COMUNICAÇÃO QUE TRANSMITE IMAGENS EM DIVERSOS CANAIS.

|    |  |  |  |  |
|----|--|--|--|--|
| 1  |  |  |  |  |
| 2  |  |  |  |  |
| 3  |  |  |  |  |
| 4  |  |  |  |  |
| 5  |  |  |  |  |
| 6  |  |  |  |  |
| 7  |  |  |  |  |
| 8  |  |  |  |  |
| 9  |  |  |  |  |
| 10 |  |  |  |  |



PESQUISE E ESCREVA ALGUMAS PALAVRAS POLISSÍLABAS COM MAIS DE QUATRO SÍLABAS. FAÇA UMA LISTA COM SUAS DESCOBERTAS E DE SEUS COLEGAS.

---

---

---

---

# CAÇA-PALAVRAS

ENCONTRE NO DIAGRAMA DEZ PALAVRAS POLISSÍLABAS E ESCREVA-AS EM SEGUIDA, FAZENDO A SEPARAÇÃO SILÁBICA.



|   |   |   |   |   |   |   |   |   |   |   |   |   |   |   |   |
|---|---|---|---|---|---|---|---|---|---|---|---|---|---|---|---|
| D | R | O | A | C | R | E | R | R | E | O | T | F | U | O | C |
| E | S | P | E | T | A | C | U | L | A | R | O | O | G | J | O |
| B | O | A | T | K | O | P | H | U | F | T | N | X | A | N | N |
| I | D | N | O | O | R | R | U | N | E | S | E | T | P | G | S |
| C | K | A | N | C | A | O | L | H | G | O | L | Q | A | S | O |
| I | Z | N | G | O | F | I | O | R | F | P | A | T | R | L | A |
| C | F | A | V | G | T | B | N | B | Y | O | D | S | T | K | N |
| L | M | E | D | I | C | I | N | A | F | T | A | L | A | P | T |
| E | J | E | V | C | B | D | F | D | L | G | D | F | M | S | E |
| T | X | H | C | E | R | O | J | A | D | Z | L | A | E | E | F |
| A | T | E | R | R | E | M | O | T | O | U | S | A | N | H | I |
| P | D | G | T | R | H | F | B | Y | A | C | M | C | T | N | S |
| O | P | T | A | J | S | C | R | P | T | I | I | A | O | G | E |
| F | A | N | T | A | S | T | I | C | O | A | R | E | G | A | M |
| B | G | D | B | V | X | F | T | U | E | H | D | A | P | U | O |
| U | B | E | V | C | C | O | P | A | B | D | O | F | T | B | R |
| A | C | G | E | S | P | A | C | I | A | L | M | U | B | E | O |

|  |
|--|
|  |
|  |
|  |
|  |
|  |
|  |
|  |
|  |
|  |
|  |
|  |

# SÍLABAS



ESCREVA OS NOMES DAS FIGURAS, SEPRE AS SÍLABAS DAS PALAVRAS E CLASSIFIQUE-AS EM MONOSSÍLABAS, DISSÍLABAS, TRISSÍLABAS OU POLISSÍLABAS.



\_\_\_\_\_

\_\_\_\_\_

\_\_\_\_\_



\_\_\_\_\_

\_\_\_\_\_

\_\_\_\_\_



\_\_\_\_\_

\_\_\_\_\_

\_\_\_\_\_



\_\_\_\_\_

\_\_\_\_\_

\_\_\_\_\_

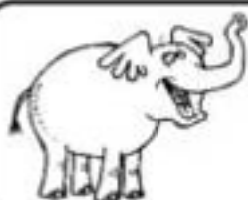

\_\_\_\_\_

\_\_\_\_\_

\_\_\_\_\_



\_\_\_\_\_

\_\_\_\_\_

\_\_\_\_\_

NA ATIVIDADE ACIMA, VOCÊ USOU TODOS OS TIPOS DE CLASSIFICAÇÃO SILÁBICA? SE A RESPOSTA FOR NÃO, QUAL FICOU DE FORA? SE VOCÊ CONHECE ALGUMA PALAVRA COM ESSA CLASSIFICAÇÃO, ESCREVA-A ABAIXO.

# JOGO DOS ERROS

NO QUADRO "A", ESTÃO QUATRO FIGURAS MONOSSÍLABAS, QUATRO DISSÍLABAS, QUATRO TRISSÍLABAS E QUATRO POLISSÍLABAS. PORÉM, ALGUMAS DESTAS FIGURAS NÃO TIVERAM OS NOMES ESCRITOS NO QUADRO "B". DESCUBRA QUAIS SÃO E ESCRVA SEUS NOMES NO LUGAR ADEQUADO. COMPLETE OS QUADROS PARA QUE TODOS TENHAM O MESMO NÚMERO DE PALAVRAS.

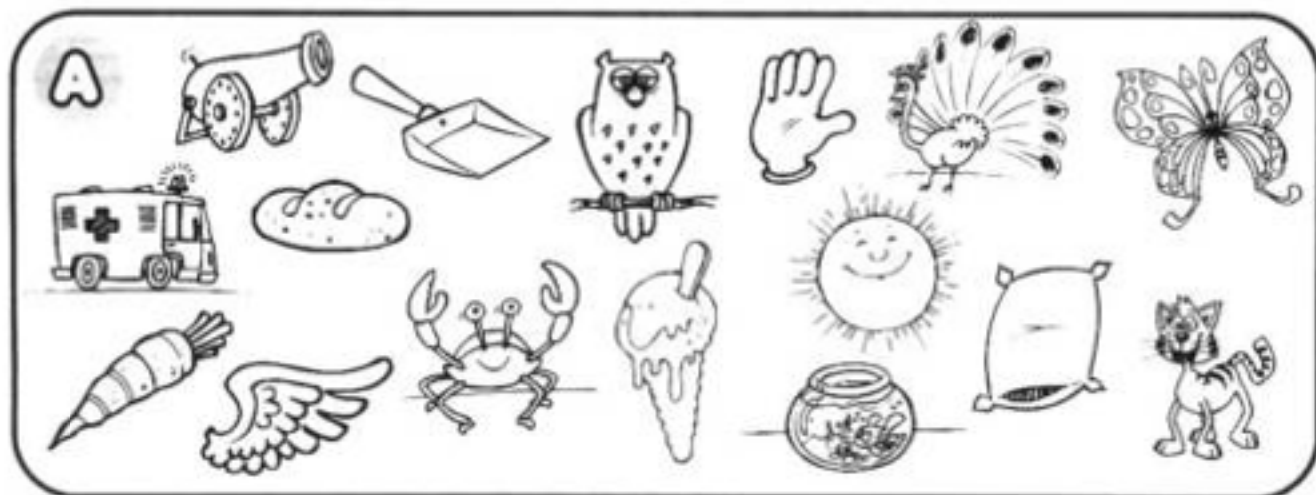

**B**

|                   |                |                    |
|-------------------|----------------|--------------------|
|                   | <b>SORVETE</b> | <b>CANHÃO</b>      |
| <b>CARANGUEJO</b> | <b>PÁ</b>      | <b>TRAVESSEIRO</b> |
|                   | <b>GATO</b>    | <b>MÃO</b>         |
| <b>AQUÁRIO</b>    | <b>SOL</b>     | <b>BORBOLETA</b>   |

| MONOSSÍLABAS | DISSÍLABAS | TRISSÍLABAS | POLISSÍLABAS |
|--------------|------------|-------------|--------------|
|              |            |             |              |
|              |            |             |              |
|              |            |             |              |
|              |            |             |              |
|              |            |             |              |



# DESAFIO

USE AS SÍLABAS ABAIXO PARA ESCREVER O QUE SE PEDE.



TRÊS PALAVRAS DISSÍLABAS INICIADAS COM "C".

---

---

UMA PALAVRA POLISSÍLABA.

---

---

DUAS PALAVRAS TRISSÍLABAS.

---

---

TRÊS PALAVRAS DISSÍLABAS INICIADAS COM "D".

---

---

QUE OUTRAS PALAVRAS VOCÊ CONSEGUE FORMAR COM ESTAS SÍLABAS?

---

---



# RECORTE E COLE

RECORTE E COLE CADA FIGURA DE ACORDO COM A LEGENDA.

|                  |                          |
|------------------|--------------------------|
| <b>1 SÍLABA</b>  | <b>2 SÍLABAS</b>         |
| <b>3 SÍLABAS</b> | <b>4 OU MAIS SÍLABAS</b> |

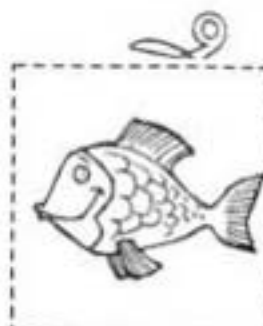
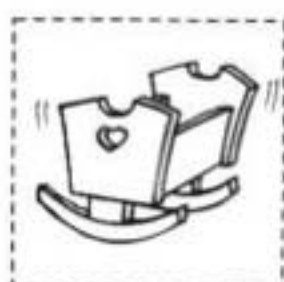
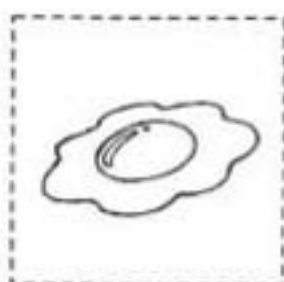

# CRUZANDO SÍLABAS

PREENCHA A CRUZADINHA COM AS PALAVRAS DO QUADRO, SEPARANDO-AS EM SÍLABAS.

|  2 SÍLABAS |  3 SÍLABAS  |  4 SÍLABAS |  5 SÍLABAS |
|---|--|---|---|
| HINO<br>TELA<br>LUA<br>BOLA   | EMOÇÕES<br>FANTASMA<br>INJEÇÕES<br>MIADO<br>RALADOR<br>DOENTE<br>MATAGAL<br>DOMINGO<br>GOELA | ELEFANTE<br>MARACUJÁ<br>TAGARELA<br>DORMITÓRIO<br>TELEFONE<br>JENIPAPO<br>MAGOADO           | HIPOPÓTAMO<br>TELEFONISTA   |

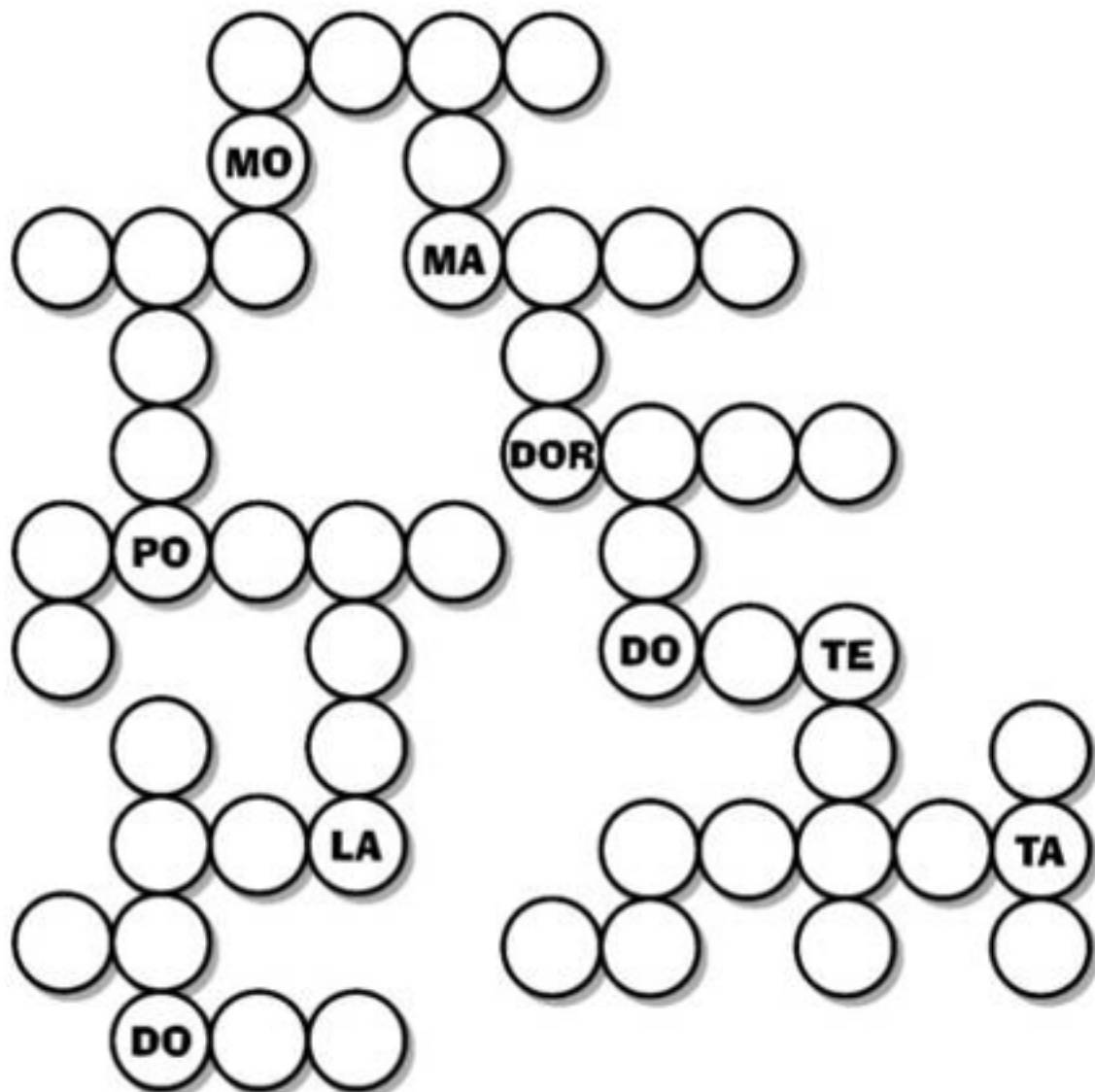

# FORMANDO PALAVRAS

ESCREVA QUATRO PALAVRAS FORMADAS POR:

**4 SÍLABAS**



Four horizontal lines for writing words with 4 syllables.



**3 SÍLABAS**



Four horizontal lines for writing words with 3 syllables.



**2 SÍLABAS**



Four horizontal lines for writing words with 2 syllables.



**1 SÍLABA**



Four horizontal lines for writing words with 1 syllable.



# PENSANDO BEM...

OBSERVE CADA QUADRO E ANOTE AS SÍLABAS QUE NÃO PERTENCEM AO GRUPO. JUSTIFIQUE SUA RESPOSTA.



---

---

---



---

---

---



---

---

---



---

---

---



---

---

---

# CAÇA-SÍLABAS

REESCREVA OS NOMES DAS FIGURAS UTILIZANDO SOMENTE AS SÍLABAS NECESSÁRIAS.



LE AR XI MA A DU LI RA

---



VO LI FO LÃO O GÃO TA NO

---



E FE TE LE O FO LE NE

---



LO COM LU PU DA TA FLOR DOR

---



JU CHA CHU TEI VEI NA RO VO

---



BA TE TI RAI RÁ LO DIO FO

---

# TROCA-SÍMBOLOS

SUBSTITUA OS SÍMBOLOS PELAS SÍLABAS CORRESPONDENTES E ENCONTRE OS NOMES DE ALGUNS ESTADOS BRASILEIROS.

|  |  |  |   |   |  |   |   |   |
|--|--|--|---|---|--|---|---|---|
| <br>NOR | <br>PER | <br>PI  | <br>LO | <br>GRAN | <br>A   | <br>AU  | <br>TO | <br>TINS |
| <br>BU  | <br>SÃO | <br>DO  | <br>DE | <br>CO   | <br>CAN | <br>Í   | <br>ES | <br>PAU  |
| <br>SUL | <br>SAN | <br>RIO | <br>RI | <br>NAM  | <br>TE  | <br>NAS | <br>MA | <br>ZO   |

      \_\_\_\_\_

     \_\_\_\_\_

   \_\_\_\_\_

      \_\_\_\_\_

    \_\_\_\_\_

   \_\_\_\_\_

   \_\_\_\_\_

    \_\_\_\_\_

# PENSE BEM

ORGANIZE AS SÍLABAS PARA ESCREVER OS NOMES DAS FIGURAS.



LHO CO E



BRA ZE

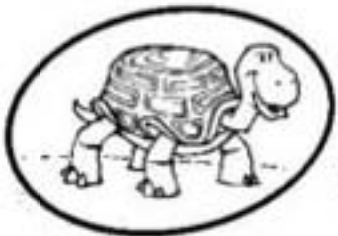

TA RU  
GA TAR

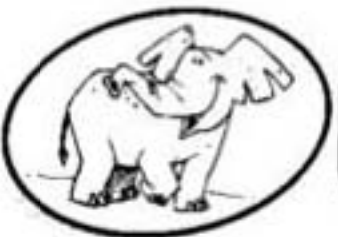

FAN LE  
TE E

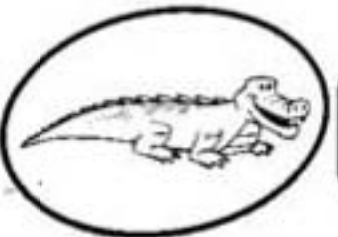

RÉ CA JA

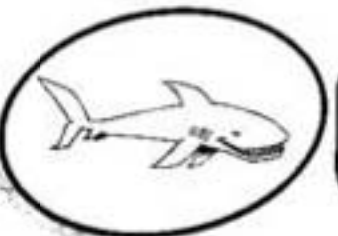

RÃO BA TU



BRA CO



# COMPLETANDO PALAVRAS

USE AS SÍLABAS DO QUADRO ABAIXO PARA COMPLETAR AS PALAVRAS.



A\_\_BADO

CE\_\_LA

\_\_MA

CA\_\_SETA

\_\_NELA

A\_\_LHA

CA\_\_LO

\_\_RETA

\_\_GUETE

SALA\_\_

MA\_\_

FA\_\_

\_\_REDE

\_\_LHO

\_\_ELHO

AN\_\_NA

\_\_ALHADA

\_\_PEL

\_\_MIDA

\_\_ME

\_\_SACO

PA\_\_NHA

\_\_SOURO

TER\_\_METRO

\_\_BUTICABA

PA\_\_DAR

\_\_LHA

A\_\_GO

POMA\_\_

\_\_LEVISÃO

\_\_DARIA

FOR\_\_GA

MÚSI\_\_

MA\_\_RRÃO

PI\_\_MA

\_\_CADA

AL\_\_FADA

\_\_LEFONE

TU\_\_NO



# COMPLETANDO COM SÍLABAS

USE AS SÍLABAS ABAIXO E COMPLETE AS PALAVRAS. CADA UMA PODE SER USADA MAIS DE UMA VEZ.



FA VE FI VO  
VA FE VI FO

RRO

ALMODA

CA

TELENE

DA

ALNETE

IJÃO

TA

OLÃO

AÃO

U

LA

CA

ÁRRE

CHA

FILA

# FORMANDO PALAVRAS

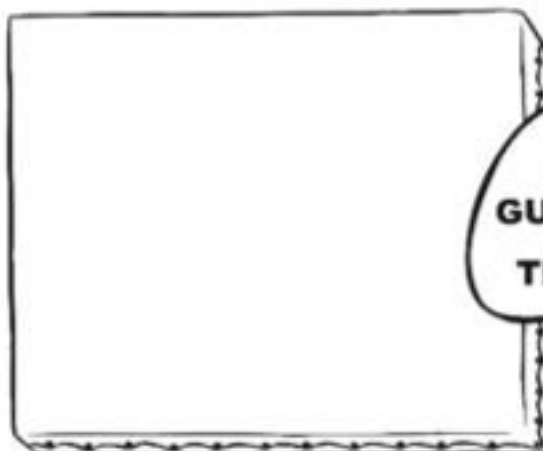

ORGANIZE AS SÍLABAS E ESCREVA O NOME SECRETO. DESENHE O QUE VOCÊ ENCONTROU.



# MINI-CRUZADINHA

COMPLETE AS MINI-CRUZADINHAS COM AS SÍLABAS DO QUADRO. CADA SÍLABA PODE SER USADA MAIS DE UMA VEZ.

|    |    |    |    |    |
|----|----|----|----|----|
| TU | DI | DO | DU | TA |
| DA | TO | TI | TE | DE |

|    |     |   |     |   |    |     |   |     |     |
|----|-----|---|-----|---|----|-----|---|-----|-----|
| CA |     | A   |     |   |    | SO  |   | RAN |     |
|    | PÓ  |   | CU  |  |    | SE  |   |     | SOU |
|    | SI  |   | MEN |   |    | NHO |  |     | RA  |
|    |     |   |     | MA  |    |     |   | CHA |     |
|    |     | A   | MAN |   |    | E   |   |     | BA  |
|    | NOS |   |     | LE  | SA | PA  |   |     | RIS |
|    | SAU |  |     | FO  |    |     |   | NI  |     |
|    | RO  |   |     | NE  |    | PE  |   | CA  | NHA |
|    |     |   |     |   | BE |     |   | A   |     |
|    | CO  | MI  |     |   | LA |     | TRO   |     | CI  |
|    |     |   | MAS |   |    |     |   | LI  |     |
|    | PA  | CO  |     |   |    |     |   | PA  | RE  |
|    |     |   |     |   |    |     |   |     |     |

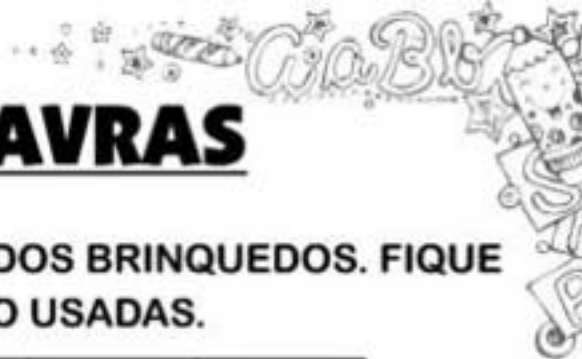

# FORMANDO PALAVRAS

ORDENE AS SÍLABAS E ESCREVA OS NOMES DOS BRINQUEDOS. FIQUE ATENTO, POIS ALGUMAS SÍLABAS NÃO SERÃO USADAS.



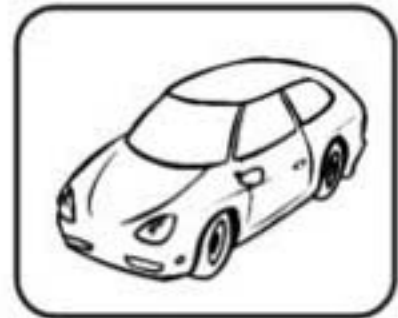
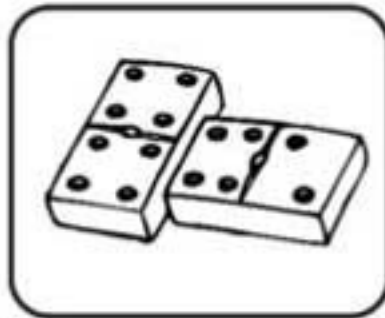
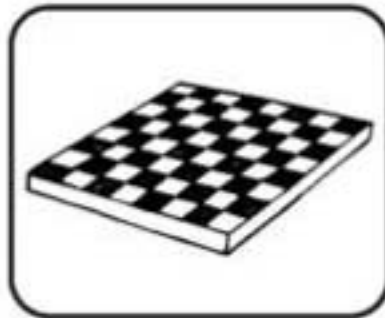
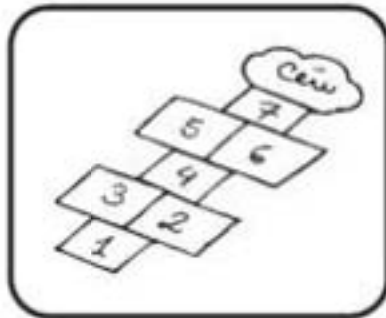
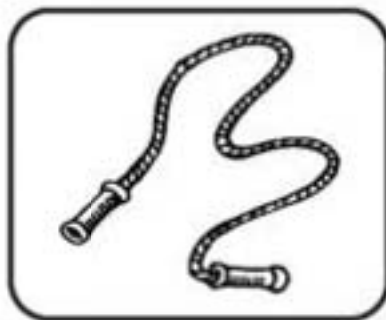

































|    |    |     |     |      |     |    |
|----|----|-----|-----|------|-----|----|
| PI | DA | BI  | MI  | RI   | CA  | MA |
| PE | BO | MON | LU  | TE   | COR | PI |
| NE | TO | CAR | LA  | GA   | ME  | SU |
| RE | TO | QUE | ÃO  | NHA  | LI  | NÓ |
| BO | DO | CA  | NHO | DREZ | XA  | A  |



# TROCA-SÍMBOLOS

SUBSTITUA OS SÍMBOLOS PELAS SÍLABAS CORRESPONDENTES PARA  
DESCOBRIR AS PALAVRAS SECRETAS.

|   |   |   |   |   |   |   |   |  |   |   |   |   |
|---|---|---|---|---|---|---|---|--|---|---|---|---|
|  |  |  |  |  |  |  |  |  |  |  |  |  |
| O   | VI  | DEI   | LÃO   | RO  | PAN   | SAN   | NA  | TE   | A   | BA  | TA  | FLAU  |
|  |  |  |  |  |  |  |  |  |  |  |  |  |
| FO  | RI  | LI  | XO  | BO  | BAI   | TU  | CLA   | PI   | SA  | NE  | NO  | TROM  |

|   |   |   |  |   |   |  |   |       |
|---|---|---|--|---|---|--|---|-------|
|    |    | _____   |   |    |   |   | _____   |       |
|    |    | _____   |   |    |   | _____  |   |       |
|   |   | _____   |  |   |  |  | _____   |       |
|  |  |  | _____  |  |  |  |  | _____ |
|  |  |  | _____  |  |  |  | _____   |       |
|  |  |  | _____  |  |  |   |   | _____ |

O QUE VOCÊ SABE SOBRE ESTAS PALAVRAS?

---



---



---



---



---



---

# JOGO DA SÍLABA

ORDENE AS SÍLABAS DE CADA GRUPO E ESCREVA AS PALAVRAS.

BU LÂN AM CIA \_\_\_\_\_

BE TA TROM \_\_\_\_\_

BA COM TE \_\_\_\_\_

PU DOR TA COM \_\_\_\_\_

BU BAM \_\_\_\_\_

TO PE NA O CAM \_\_\_\_\_

LHO BRU EM \_\_\_\_\_

NÊS CAM PO \_\_\_\_\_

BO LO SÍM \_\_\_\_\_

RA TU PE TEM RA \_\_\_\_\_

# ENCAIXA-SÍLABAS

ESCREVA AS RESPOSTAS DAS QUESTÕES NOS ESPAÇOS ADEQUADOS SEPARANDO-AS EM SÍLABAS. PINTE OS QUADRADINHOS QUE NÃO SERÃO USADOS.

• COLOQUE UMA SÍLABA EM CADA QUADRADINHO.



|    |  |  |  |  |  |  |
|----|--|--|--|--|--|--|
| 1  |  |  |  |  |  |  |
| 2  |  |  |  |  |  |  |
| 3  |  |  |  |  |  |  |
| 4  |  |  |  |  |  |  |
| 5  |  |  |  |  |  |  |
| 6  |  |  |  |  |  |  |
| 7  |  |  |  |  |  |  |
| 8  |  |  |  |  |  |  |
| 9  |  |  |  |  |  |  |
| 10 |  |  |  |  |  |  |
| 11 |  |  |  |  |  |  |
| 12 |  |  |  |  |  |  |

1 - OBJETO USADO COM CREME DENTAL PARA A HIGIENE BUCAL.

2 - FRUTO DA JABUTICABEIRA.

3 - ÁRVORE DA CANELA.

4 - HISTÓRIA CURTA E ENGRAÇADA.

5 - MATERIAL FEITO COM O PÊLO DA OVELHA.

6 - ROUPA USADA PARA DORMIR.

7 - OS BOMBEIROS AJUDAM A COMBATÊ-LO.

8 - NELE SÃO CRIADOS OS PEIXES ORNAMENTAIS.

9 - LUGAR DA CASA RESERVADO PARA DORMIR.





10 - DOCE FEITO COM COCO.





11 - OBJETO USADO NO ROSTO PARA AUXILIAR A VISÃO.





12 - PARTE QUE APÓIA TODO O PESO DO CORPO QUANDO ELE ESTÁ EM PÉ.





# PALAVRAS MISTERIOSAS

ESCREVA A PRIMEIRA SÍLABA DO NOME DE CADA FIGURA E DESCUBRA AS PALAVRAS MISTERIOSAS.



# MONTA-MONTA SILÁBICO

ORGANIZE AS SÍLABAS PARA MONTAR AS PALAVRAS. ACENTUE QUANDO NECESSÁRIO.



|    |    |     |    |    |    |    |     |    |    |
|----|----|-----|----|----|----|----|-----|----|----|
| 1  | 2  | 3   | 4  | 5  | 6  | 7  | 8   | 9  | 10 |
| A  | BA | NE  | FE | TI | ZA | GA | CI  | MA | NO |
| 11 | 12 | 13  | 14 | 15 | 16 | 17 | 18  | 19 | 20 |
| CE | NA | MI  | RE | DU | CA | JA | DE  | RO | TA |
| 21 | 22 | 23  | 24 | 25 | 26 | 27 | 28  | 29 | 30 |
| DI | LI | MAN | SE | DA | PA | GO | NHA | TE | O  |

$1+13+6+18=$  \_\_\_\_\_

$4+22+8+25+18=$  \_\_\_\_\_

$8+25+18=$  \_\_\_\_\_

$1+13+27=$  \_\_\_\_\_

$30+11+1+10=$  \_\_\_\_\_

$21+1=$  \_\_\_\_\_

$21+1+23+29=$  \_\_\_\_\_

$20+23+15+1=$  \_\_\_\_\_

$1+9+14+22+28=$  \_\_\_\_\_

$22+28=$  \_\_\_\_\_

$16+13+28=$  \_\_\_\_\_

$29+22+28=$  \_\_\_\_\_

$9+20=$  \_\_\_\_\_

$24+9+12=$  \_\_\_\_\_

$29+9=$  \_\_\_\_\_

$8+3+9=$  \_\_\_\_\_

$27+5+28=$  \_\_\_\_\_



QUE TAL FORMAR ALGUMA PALAVRA QUE NÃO ESTAVA NA LISTA ACIMA?  
MÃOS À OBRA. UTILIZE TAMBÉM AS SÍLABAS QUE NÃO FORAM USADAS.

---

---

---

# NOMES SECRETOS

ESCREVA AS SÍLABAS PEDIDAS DE CADA PALAVRA E DESCUBRA QUAIS SÃO OS NOMES SECRETOS.

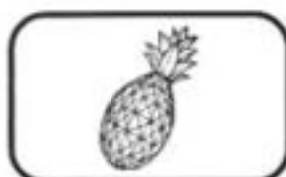

1ª SÍLABA



1ª SÍLABA

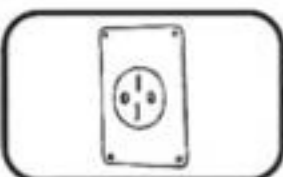

3ª SÍLABA

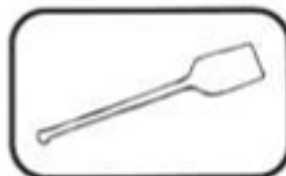

1ª SÍLABA



1ª SÍLABA

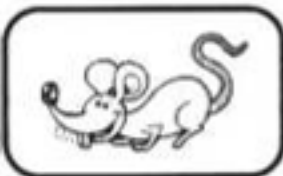

2ª SÍLABA



1ª SÍLABA

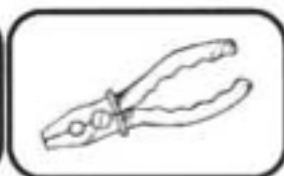

2ª SÍLABA

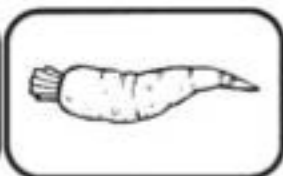

1ª SÍLABA



1ª SÍLABA

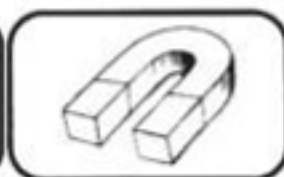

1ª SÍLABA



2ª SÍLABA

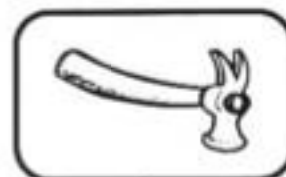

1ª SÍLABA

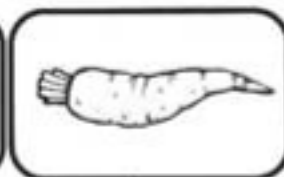

1ª SÍLABA



2ª SÍLABA

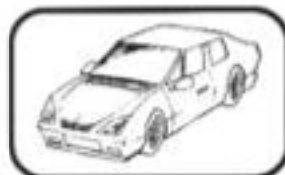

1ª SÍLABA



2ª SÍLABA

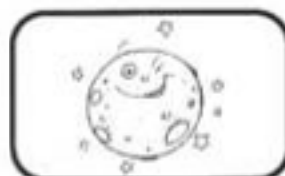

1ª SÍLABA



1ª SÍLABA

# ENIGMA

DECIFRE O QUE ESTÁ ESCRITO, ORGANIZANDO AS SÍLABAS PARA FORMAR AS PALAVRAS DOS VERSOS.



# SALADA DE SÍLABAS

DONA MARISA FOI LER A LISTA DE FRUTAS QUE SEU FILHO FEZ PARA PREPARAR UMA SALADA DE FRUTAS, MAS ELE ESCREVEU OS NOMES DE UMA FORMA DIFERENTE. AJUDE DONA MARISA A COMPREENDER ESTA LISTA, REESCREVENDO OS NOMES DAS FRUTAS.

GOSEPÊS \_\_\_\_\_

XECARIME \_\_\_\_\_

GAMAN \_\_\_\_\_

NABANA \_\_\_\_\_

BAXIACA \_\_\_\_\_

RAPÊ \_\_\_\_\_

RANMOGO \_\_\_\_\_

LANMECIA \_\_\_\_\_

MÃOMA \_\_\_\_\_

LÃOME \_\_\_\_\_



# FORMANDO PALAVRAS

SEPARE AS SÍLABAS DAS FIGURAS E USE-AS PARA ESCREVER AS PALAVRAS INDICADAS.



BO — NECA \_\_\_\_\_ BONECA \_\_\_\_\_  
LO — BOLO \_\_\_\_\_  
LICHE — BOLICHE \_\_\_\_\_

LA — TA \_\_\_\_\_ LATA \_\_\_\_\_  
RANJA — LARANJA \_\_\_\_\_  
ÇO — LAÇO \_\_\_\_\_



— RETA \_\_\_\_\_  
— RUAGEM \_\_\_\_\_  
— RIOLA \_\_\_\_\_

— SA \_\_\_\_\_  
— DO \_\_\_\_\_  
— BÔ \_\_\_\_\_



— MENTA \_\_\_\_\_  
— ANO \_\_\_\_\_  
— ADA \_\_\_\_\_

— PEL \_\_\_\_\_  
— NELA \_\_\_\_\_  
— DARIA \_\_\_\_\_



— DAÇO \_\_\_\_\_  
— LO \_\_\_\_\_  
— LICANO \_\_\_\_\_

— VIO \_\_\_\_\_  
— MORADA \_\_\_\_\_  
— BO \_\_\_\_\_



— NECA \_\_\_\_\_  
— LO \_\_\_\_\_  
— GRA \_\_\_\_\_

— DA \_\_\_\_\_  
— RINHA \_\_\_\_\_  
— MÍLIA \_\_\_\_\_



— MA \_\_\_\_\_  
— BERTO \_\_\_\_\_  
— MARIA \_\_\_\_\_

— BO \_\_\_\_\_  
— TERIA \_\_\_\_\_  
— JA \_\_\_\_\_

ESCOLHA UMA PALAVRA E CRIE UMA ATIVIDADE IGUAL A ESTA.



— < \_\_\_\_\_  
— < \_\_\_\_\_  
— < \_\_\_\_\_

— < \_\_\_\_\_  
— < \_\_\_\_\_  
— < \_\_\_\_\_

# FORMANDO NOMES

PINTE AS SÍLABAS QUE FORMAM O NOME DE CADA ANIMAL E  
ESCREVA-OS.



JA CÃO ME LO FO TOU CA

---



MO PA CA ME E LO TE

---



I BRA LE PA CO VÃO BE

---



TOU CO U MA PA BE CA

---



ON RI TU GA RU BRA ZE

---



ÇA FA NO GI ON RA MO

---



PO MOR PÓ TA CE MO HI

---



RON SO LIN VA UR CA DI

---



VA FA CA BU GI RA ME

---

# OS AMIGOS

LEIA AS DICAS E FORME O NOME DE SEIS AMIGOS USANDO AS SÍLABAS ABAIXO. CADA SÍLABA PODE SER UTILIZADA MAIS DE UMA VEZ.



|    |    |    |     |
|----|----|----|-----|
| CA | LI | LA | RO  |
| RI | MI | DO | PE  |
| FE | MA | NA | NAL |

1 - O NOME DELE TEM 6 LETRAS. A ÚLTIMA SÍLABA É "PE" E COMEÇA COM A LETRA "F". QUEM É ELE?

 \_\_\_\_\_

2 - O NOME DELA TEM 6 LETRAS. A 2ª SÍLABA É "MI". QUEM É ELA?

 \_\_\_\_\_

3 - O NOME DELE TEM 7 LETRAS. A PRIMEIRA LETRA É "R" E A ÚLTIMA SÍLABA É "DO". QUEM É ELE?

 \_\_\_\_\_

4 - ESTE É O MAIOR NOME DENTRE OS AMIGOS. É ESCRITO COM 8 LETRAS E A 2ª SÍLABA É "RO". QUEM É ELA?

 \_\_\_\_\_

5 - SE TIRASSE O "N" DA ÚLTIMA SÍLABA, O NOME DELA SERIA "MARIA". QUEM É ELA?

 \_\_\_\_\_

6 - O NOME DELE É MUITO PARECIDO COM O DO AMIGO, MAS ESTE COMEÇA COM "RO". QUEM É ELE?

 \_\_\_\_\_

# BATALHA SÍLABICA

SIGA AS COORDENADAS DE LETRAS E NÚMEROS PARA SABER AS RESPOSTAS DAS PERGUNTAS.

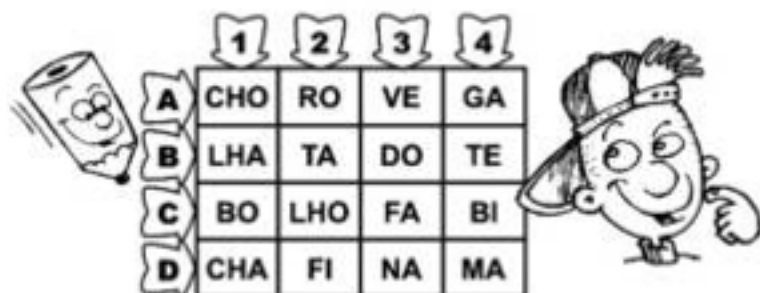

① - MASSA COMPACTA DE PEDRA MUITO DURA. A2+D1

\_\_\_\_\_

② - RAMO DE ÁRVORE. A4+C2

\_\_\_\_\_

③ - DEFEITO, FALTA. C3+B1

\_\_\_\_\_

④ - PESSOA IDOSA. A3+B1

\_\_\_\_\_

⑤ - TIPO DE PANELA GRANDE E LARGA. B2+A1

\_\_\_\_\_

⑥ - PEÇA USADA PARA TAMPAR GARRAFAS, GERALMENTE DE CORTIÇA. A2+B1

\_\_\_\_\_

⑦ - NASCIDO DA MÃE. D2+C2

\_\_\_\_\_

⑧ - USADA NA COBERTURA DE CASAS. B4+B1+B3

\_\_\_\_\_

⑨ - LUZ QUE SE LEVANTA NO FOGO. D1+D4

\_\_\_\_\_

⑩ - NOME GENÉRICO COMO É CHAMADO UM ANIMAL. C4+A1

\_\_\_\_\_

⑪ - CILINDRO USADO PARA ENROLAR MATERIAL FLEXÍVEL, COMO LINHA, PAPEL ETC. C1+C4+D3

\_\_\_\_\_



# CAÇA-PALAVRAS SILÁBICO

PINTE NO DIAGRAMA AS PALAVRAS ANOTADAS ABAIXO, SEPARADAS EM SÍLABAS.

BARRIGA  
SERRA  
SERROTE  
CORRIDA

TERRESTRE  
TERRA  
TERREMOTO  
MACARRÃO

FERRADURA  
FERRO  
REPOLHO  
TORRE

CARRO  
CARRUAGEM

|     |     |     |     |     |     |     |     |     |
|-----|-----|-----|-----|-----|-----|-----|-----|-----|
| SI  | CAR | RU  | A   | GEM | PE  | MA  | PO  | CRA |
| TRI | RO  | LA  | BUR | DRE | LO  | FER | RO  | CI  |
| E   | TO  | TOR | TRI | JO  | PE  | RA  | LO  | MA  |
| PLA | SI  | RE  | PO  | LHO | SO  | DU  | LÃO | CAR |
| TER | RE  | MO  | TO  | NAN | TER | RA  | RA  | RÃO |
| RES | CLO | RU  | A   | PEM | PE  | MA  | IS  | LA  |
| TRE | COR | COR | RI  | DA  | MA  | SER | RA  | VI  |
| GA  | VO  | CHA | CLE | TE  | TUR | RO  | MA  | TRE |
| GO  | BAR | RI  | GA  | GI  | LA  | TE  | BU  | NI  |



# O QUE ESTÁ FALTANDO?



DESCUBRA QUAIS AS SÍLABAS QUE FALTAM EM CADA GRUPO PARA ESCREVER OS NOMES DAS FIGURAS. COMPLETE CADA QUADRO SILÁBICO E ESCREVA OS NOMES DELAS.



|    |    |    |     |
|----|----|----|-----|
| NE | VI |    | TE  |
|    | LE | FO | SÃO |



|    |  |    |
|----|--|----|
|    |  | TA |
| LO |  | TO |



|    |    |    |    |
|----|----|----|----|
| CA |    | RA | FA |
| GI | BA |    |    |



|    |  |   |
|----|--|---|
| CO |  | E |
| A  |  |   |



|    |    |     |     |
|----|----|-----|-----|
| LO |    | SOR | FOR |
| MI | GA |     | VE  |



# DESAFIO

ESCREVA TRÊS PALAVRAS EM CADA GRUPO, RESPEITANDO A REGRA: A MESMA SÍLABA DEVE APAREÇER EM CADA PALAVRA NA MESMA POSIÇÃO



\_\_\_ JA NELA  
\_\_\_ PA NELA  
\_\_\_ CA NELA



PA \_\_\_\_\_  
PA \_\_\_\_\_  
PA \_\_\_\_\_



\_\_\_\_\_ MO  
\_\_\_\_\_ MO  
\_\_\_\_\_ MO



\_\_\_ LA \_\_\_  
\_\_\_ LA \_\_\_  
\_\_\_ LA \_\_\_



\_\_\_\_\_ RA  
\_\_\_\_\_ RA  
\_\_\_\_\_ RA



PI \_\_\_\_\_  
PI \_\_\_\_\_  
PI \_\_\_\_\_



FA \_\_\_\_\_  
FA \_\_\_\_\_  
FA \_\_\_\_\_



\_\_\_ BO \_\_\_  
\_\_\_ BO \_\_\_  
\_\_\_ BO \_\_\_

# FORMANDO PALAVRAS

USE AS SÍLABAS ABAIXO PARA ESCREVER OS NOMES DE DEZ ANIMAIS SELVAGENS. TODAS AS SÍLABAS PODEM SER USADAS VÁRIAS VEZES.

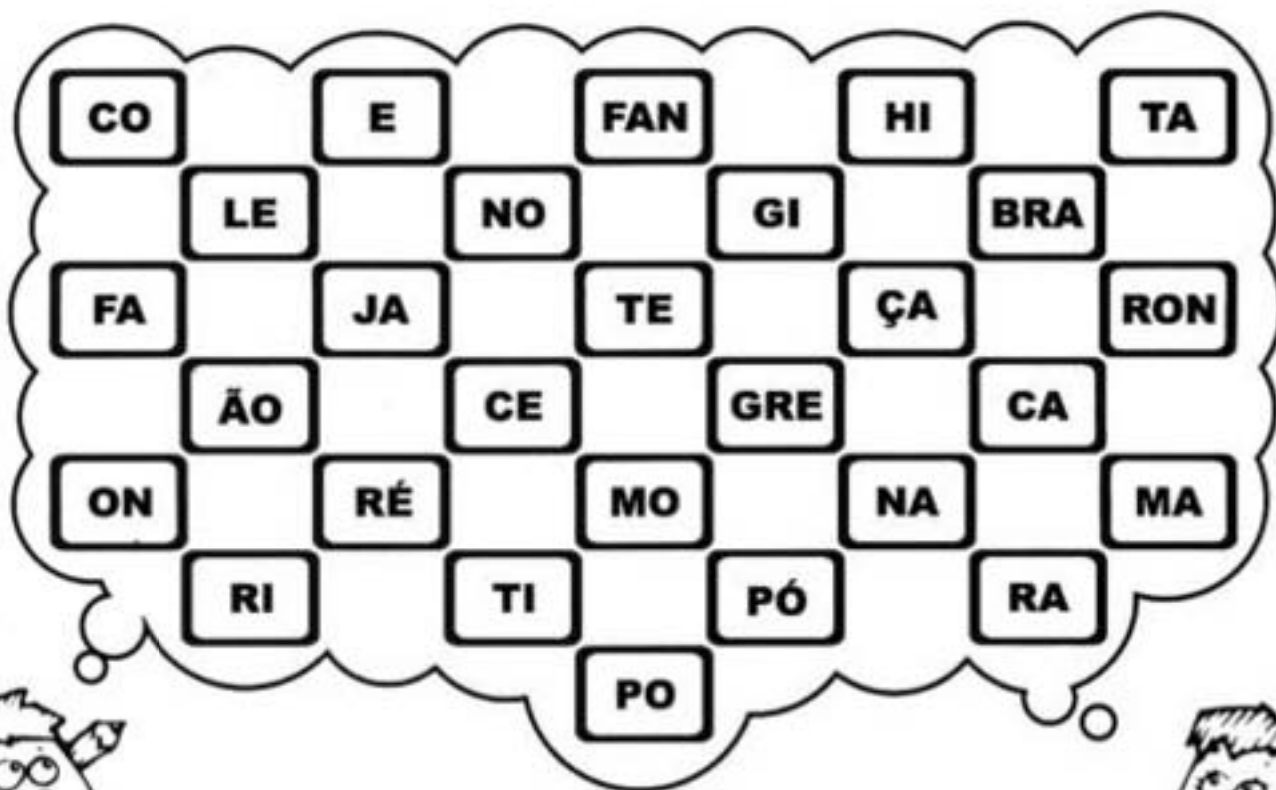

---

---

---

---

---

---

---

---







---

---

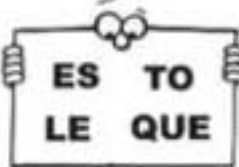
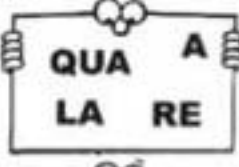

# ORDENE AS SÍLABAS

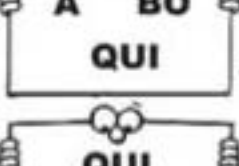
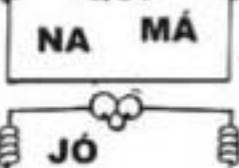
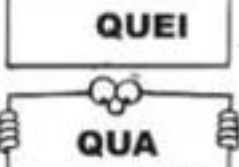
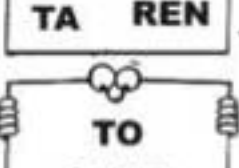
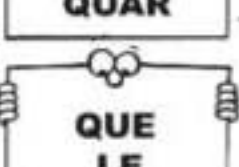
ORDENE AS SÍLABAS DE CADA QUADRO PARA ESCREVER AS PALAVRAS.

|   |       |
|---|-------|
|    | _____ |
|    | _____ |
|    | _____ |
|   | _____ |
|  | _____ |
|  | _____ |
|  | _____ |
|  | _____ |
|  | _____ |
|  | _____ |
|  | _____ |



# PENSE BEM

ESCREVA A PRIMEIRA E A ÚLTIMA SÍLABA DO NOME DE CADA FIGURA E, COM CADA UMA DELAS, ESCREVA UMA NOVA PALAVRA.



**S**ACOLA \_\_\_\_\_

**T**OMATE \_\_\_\_\_



\_\_\_\_\_  
\_\_\_\_\_



\_\_\_\_\_  
\_\_\_\_\_



\_\_\_\_\_  
\_\_\_\_\_



\_\_\_\_\_  
\_\_\_\_\_



\_\_\_\_\_  
\_\_\_\_\_



\_\_\_\_\_  
\_\_\_\_\_



\_\_\_\_\_  
\_\_\_\_\_



\_\_\_\_\_  
\_\_\_\_\_



\_\_\_\_\_  
\_\_\_\_\_



# SÍLABAS

COMPLETE OS ESPAÇOS COM DUAS PALAVRAS INICIADAS COM A MESMA SÍLABA DE CADA FIGURA.



\_\_\_\_\_

\_\_\_\_\_



\_\_\_\_\_

\_\_\_\_\_



\_\_\_\_\_

\_\_\_\_\_



\_\_\_\_\_

\_\_\_\_\_



\_\_\_\_\_

\_\_\_\_\_



\_\_\_\_\_

\_\_\_\_\_



\_\_\_\_\_

\_\_\_\_\_

# FORMANDO PALAVRAS

ESCREVA TRÊS PALAVRAS COM CADA SÍLABA ABAIXO E DEPOIS COMPARE SUAS ESCOLHAS COM OS SEUS COLEGAS.

LA

---

---

---

BE

---

---

---

FA

---

---

---

I

---

---

---

HO

---

---

---

MU

---

---

---

VE

---

---

---

U

---

---

---

TA

---

---

---

DE

---

---

---

RO

---

---

---

CI

---

---























---





# SÍMBOLOS IGUAIS

AGRUPE OS SÍMBOLOS IGUAIS E ESCREVA O NOME DE OITO PEÇAS DE VESTUÁRIO.

|   |   |   |   |   |  |
|---|---|---|---|---|--|
| <br><b>MI</b>  | <br><b>E</b>   | <br><b>LU</b>  | <br><b>A</b>     | <br><b>VES</b> | <br><b>SA</b> |
| <br><b>DO</b>  | <br><b>QUE</b> | <br><b>CA</b>  | <br><b>QUI</b>  | <br><b>VA</b>  |  |
| <br><b>TA</b>  | <br><b>CA</b>  | <br><b>BLU</b> | <br><b>NI</b>    | <br><b>JA</b>  | <br><b>TI</b> |
| <br><b>CU</b> | <br><b>TA</b> | <br><b>SE</b> | <br><b>MEI</b> | <br><b>BI</b> |  |

|   |       |
|---|-------|
|  | _____ |
|  | _____ |
|  | _____ |
|  | _____ |
|  | _____ |
|  | _____ |
|  | _____ |
|  | _____ |

# CAÇA-PALAVRAS

ENCONTRE NO DIAGRAMA DOZE PALAVRAS QUE PERTENÇAM À MESMA FAMÍLIA SILÁBICA. DEPOIS, ESCREVA-AS NAS LINHAS.



|   |   |   |   |   |   |   |   |   |   |   |   |   |   |   |   |
|---|---|---|---|---|---|---|---|---|---|---|---|---|---|---|---|
| F | V | R | O | S | A | H | J | E | D | X | L | R | F | E | C |
| S | P | O | A | G | C | T | R | O | T | P | I | I | E | J | A |
| F | R | I | T | L | I | N | O | R | F | Z | A | N | A | O | G |
| X | U | B | R | E | L | O | G | I | O | G | D | O | O | V | B |
| C | A | L | L | P | I | E | N | A | F | M | A | C | T | I | D |
| A | L | E | O | J | C | P | U | G | A | S | O | E | O | T | E |
| B | D | E | F | S | R | E | I | M | L | J | D | R | E | C | V |
| H | Y | P | R | O | L | O | B | T | A | D | R | O | D | A | T |
| T | B | C | S | K | B | A | N | T | Y | F | D | N | N | G | V |
| R | O | D | O | O | E | O | R | U | E | R | T | T | C | C | A |
| O | U | B | X | N | P | A | H | A | F | O | N | E | N | K | T |
| H | C | F | E | A | T | N | I | G | O | A | R | A | M | A | T |
| A | H | R | A | P | O | S | A | A | G | K | E | A | O | C | N |
| C | A | U | F | B | O | E | P | T | O | E | M | O | R | C | V |
| P | I | A | U | E | A | G | C | R | A | T | O | L | O | S | E |
| R | R | A | D | I | O | N | U | R | E | G | U | A | S | O | O |
| E | T | A | A | H | M | E | O | N | O | T | S | U | I | R | R |



# QUAL É A PALAVRA?

USE AS SÍLABAS DO QUADRO PARA ESCREVER OS NOMES DAS FIGURAS. ALGUMAS SÍLABAS NÃO SERÃO NECESSÁRIAS E OUTRAS PODERÃO SER USADAS VÁRIAS VEZES.

|    |    |     |    |    |    |    |    |    |
|----|----|-----|----|----|----|----|----|----|
| ÃO | LA | PI  | MA | CO | MI | TE | VI | BO |
| PE | VO | TRA | FO | NE | CA | LE | A  | SA |

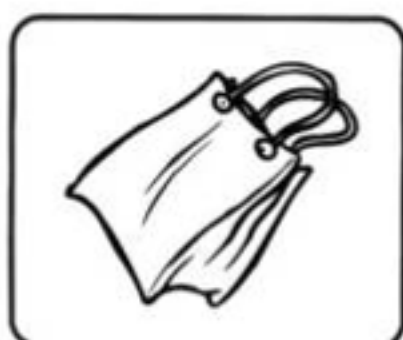

# COMPLETANDO PALAVRAS

VEJA AS FIGURAS E ESCREVA AS SÍLABAS QUE FALTAM PARA COMPLETÁ-LAS.



A LHA



BI DE



FO



TO



VETA

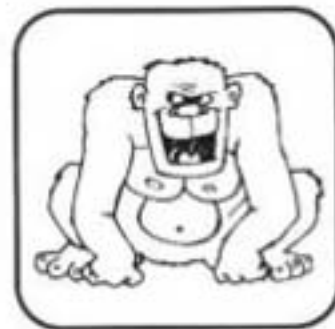

RILA

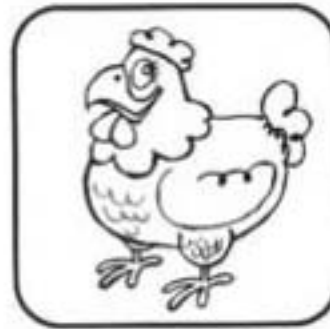

LINHA

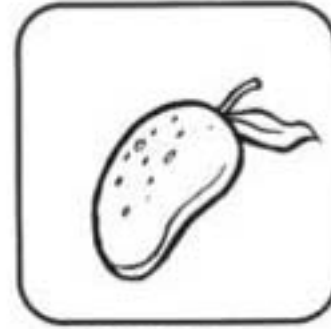

MAN



FANHOTO



TA

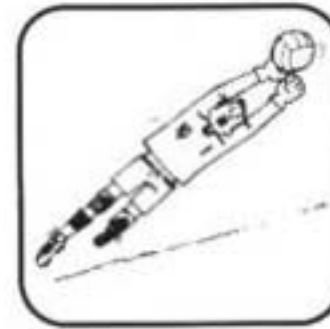

LEIRO



MORCE

A QUAL FAMÍLIA SILÁBICA PERTENCEM AS SÍLABAS QUE VOCÊ USOU?

\_\_\_\_\_

# QUEBRA-CUCA

PARA COMPLETAR A TRILHA ABAIXO, ESCREVA OS NOMES DAS FIGURAS, MAS ATENÇÃO: A ÚLTIMA SÍLABA DE CADA PALAVRA SERÁ A PRIMEIRA SÍLABA DA PALAVRA SEGUINTE.

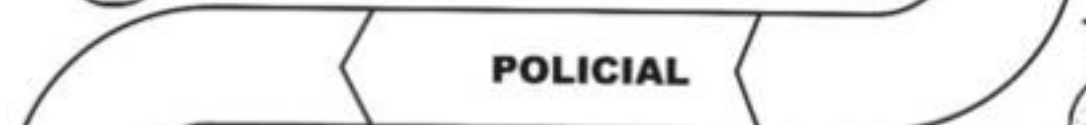
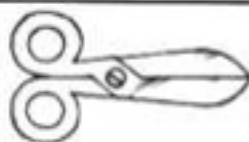
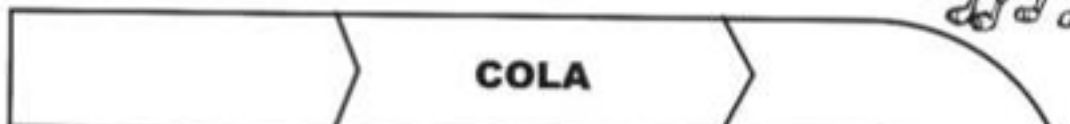
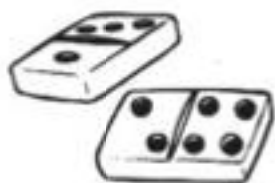

# DESAFIO SILÁBICO

ESCREVA QUANTAS PALAVRAS CONSEGUIR COM AS SÍLABAS ABAIXO.  
ATENÇÃO PARA A REGRA: TODAS AS PALAVRAS DEVEM SER DA FAMÍLIA  
SILÁBICA VA,VE,VI,VO,VU.

LU CA TO A CI GEM LA LÃO O  
LHO ão NA RIA LO DA DE NE LE



# LETRAS E SÍMBOLOS

USE A MESMA LETRA PARA OS SÍMBOLOS IGUAIS E ESCREVA OS NOMES DE NOVE CONTOS DE FADAS.





# JOGO DAS SÍLABAS

QUANTAS PALAVRAS VOCÊ CONSEGUE FORMAR COM AS SÍLABAS ABAIXO? SE VOCÊ ESCREVER DEZ, ESTÁ BOM, SE CONSEGUIR MAIS DE VINTE, VOCÊ ESTÁ DEMAIS!

ES    CA    NE    LHO  
 PA   TO    PE   SA   TA   LA    DA

|  |  |
|--|--|
|  |  |
|  |  |
|  |  |
|  |  |
|  |  |
|  |  |
|  |  |
|  |  |
|  |  |
|  |  |
|  |  |
|  |  |
|  |  |
|  |  |
|  |  |
|  |  |
|  |  |
|  |  |
|  |  |
|  |  |
|  |  |



# CRUZADINHA SABOROSA

COMPLETE A CRUZADINHA COM OS NOMES DE DEZ ALIMENTOS DO BANCO DE PALAVRAS.

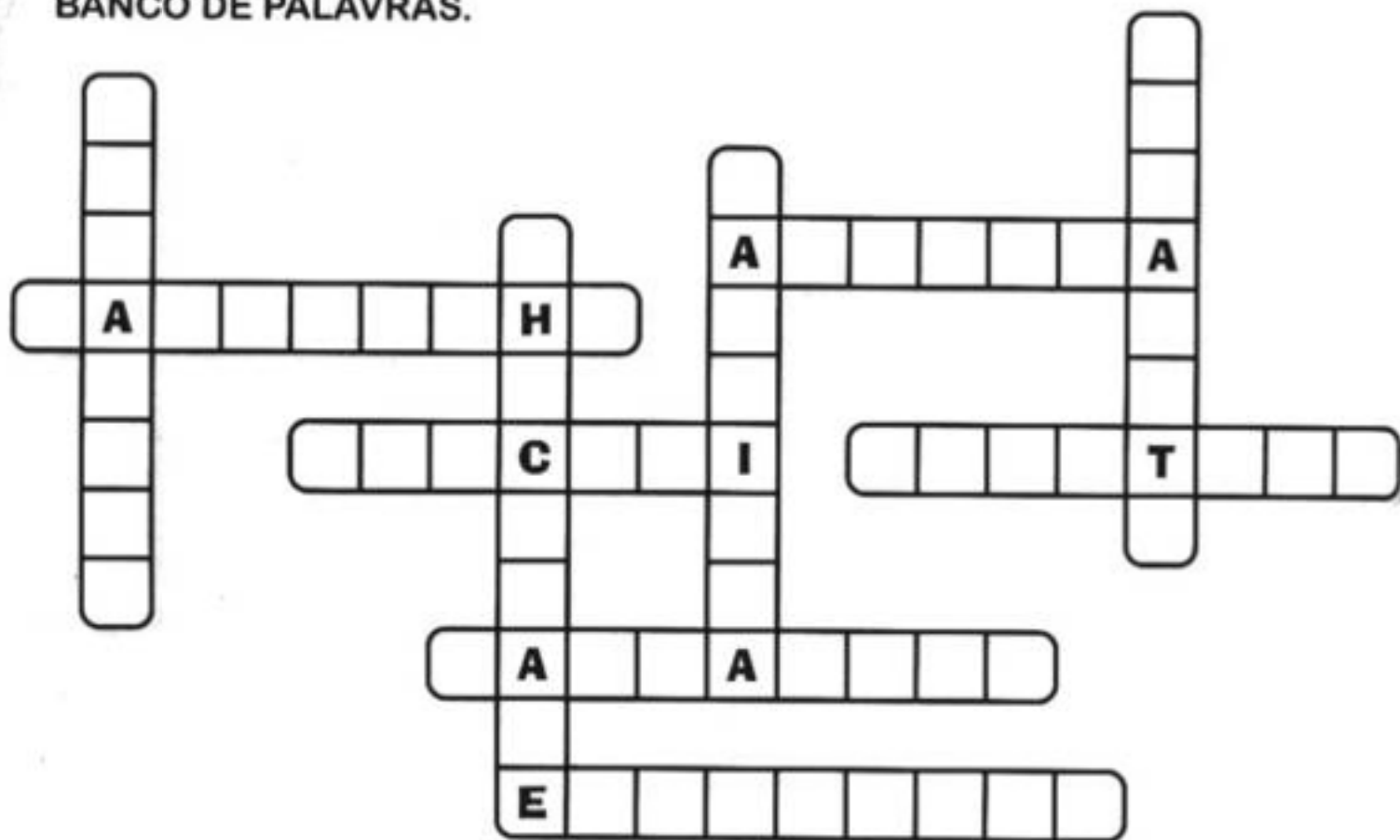

# EXPLORANDO A CRUZADINHA

RESPONDA AS QUESTÕES COM AS PALAVRAS DA CRUZADINHA SABOROSA.



QUAIS PALAVRAS DA CRUZADINHA TÊM EM COMUM O NÚMERO DE SÍLABAS?

---

QUAIS PALAVRAS TERMINAM COM A MESMA SÍLABA?

---

---

QUAIS PALAVRAS POSSUEM SÍLABAS REPETIDAS?

---

QUAIS PALAVRAS POSSUEM SÍLABAS DE UMA SÓ LETRA?

---

---

QUAIS PALAVRAS POSSUEM SÍLABAS DE TRÊS LETRAS?

---

---

ESCREVA AS PALAVRAS DA CRUZADINHA EM ORDEM ALFABÉTICA.

---

---

---

---



# ENCAIXA-SÍLABAS

COMPLETE A CRUZADINHA ANOTANDO EM CADA QUADRINHO UMA SÍLABA DA PALAVRA. PINTE OS QUADRINHOS QUE NÃO USAR.



|  |  |  |  |  |
|--|--|--|--|--|
|  |  |  |  |  |
|--|--|--|--|--|



|  |  |  |  |  |
|--|--|--|--|--|
|  |  |  |  |  |
|--|--|--|--|--|



|  |  |  |  |  |
|--|--|--|--|--|
|  |  |  |  |  |
|--|--|--|--|--|



|  |  |  |  |  |
|--|--|--|--|--|
|  |  |  |  |  |
|--|--|--|--|--|



|  |  |  |  |  |
|--|--|--|--|--|
|  |  |  |  |  |
|--|--|--|--|--|



|  |  |  |  |  |
|--|--|--|--|--|
|  |  |  |  |  |
|--|--|--|--|--|



|  |  |  |  |  |
|--|--|--|--|--|
|  |  |  |  |  |
|--|--|--|--|--|

A QUAL FAMÍLIA SILÁBICA PERTENCEM AS PALAVRAS QUE VOCÊ ESCREVEU? PESQUISE E ESCREVA OUTRAS PALAVRAS DESTA FAMÍLIA SILÁBICA.

---

---

---

---

---



# CRUZA-SÍLABAS

COMPLETE A CRUZADINHA COM OS NOMES DE ANIMAIS E INSETOS ABAIXO, ESCRREVENDO UMA SÍLABA EM CADA ESPAÇO.

FORMIGA - ONÇA - BALEIA - BESOURO - GAVIÃO  
ELEFANTE - PREGUIÇA - BORBOLETA - ABELHA  
CACHORRO - RINOCERONTE - TAMANDUÁ

The crossword puzzle grid is composed of empty boxes for letters. The grid is roughly shaped like a large 'L' with several internal branches. The illustrations are placed as follows:

- Jaguar: Above the top-right vertical column.
- Toucan: Above the top-right vertical column.
- Monkey: To the left of the top-left horizontal row.
- Ant: Above the top-right vertical column.
- Bee: Above the middle horizontal row.
- Whale: To the left of the middle horizontal row.
- Dog: To the right of the middle horizontal row.
- Butterfly: To the left of the bottom-left vertical column.
- Rhinoceros: To the right of the bottom-left vertical column.
- Beetle: Below the middle horizontal row.
- Squirrel: To the left of the bottom horizontal row.
- Elephant: Below the bottom horizontal row.

A small sign with the number '15' is located at the bottom center of the page.

# ORGANIZANDO

ESCREVA PALAVRAS EM QUE APAREÇAM CADA UMA DAS SÍLABAS DO QUADRO.



---

---

---

---

---

---

---

---

---

---

---

---

---

---

---

---

PENSANDO NA ATIVIDADE QUE VOCÊ REALIZOU, É POSSÍVEL AFIRMAR QUE PRECISAMOS DE PELO MENOS DUAS LETRAS PARA FORMAR UMA SÍLABA? JUSTIFIQUE.

---

---

---

# CAÇA-PALAVRAS

COMPLETE A TABELA COM OS DEZESSEIS ALIMENTOS ENCONTRADOS NO DIAGRAMA ABAIXO.

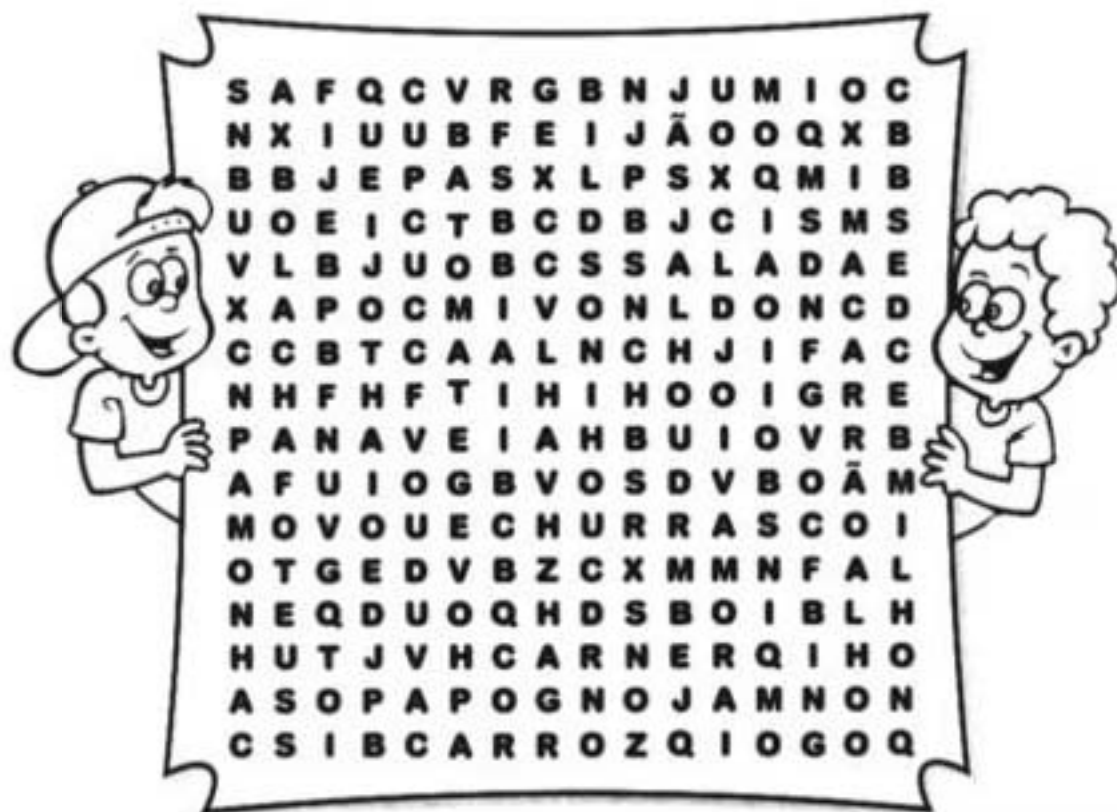

2 SÍLABAS

---

---

---

---

---

---

---

---

3 SÍLABAS

---

---

---

---

---

---

---

---

É CORRETO AFIRMAR QUE AS PALAVRAS COM O MESMO NÚMERO DE SÍLABAS POSSUEM TAMBÉM O MESMO NÚMERO DE LETRAS? POR QUÊ?

---

---

# PALAVRA PUXA PALAVRA

ESCREVA UMA PALAVRA INICIADA COM A SÍLABA INDICADA DOS NOMES DAS FIGURAS.



2ª SÍLABA \_\_\_\_\_



ÚLTIMA SÍLABA \_\_\_\_\_

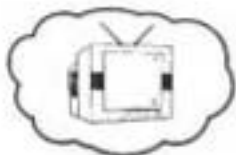

1ª SÍLABA \_\_\_\_\_



2ª SÍLABA \_\_\_\_\_

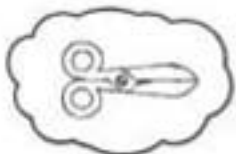

3ª SÍLABA \_\_\_\_\_



1ª SÍLABA \_\_\_\_\_



3ª SÍLABA \_\_\_\_\_



2ª SÍLABA \_\_\_\_\_



2ª SÍLABA \_\_\_\_\_



1ª SÍLABA \_\_\_\_\_

# DESAFIO



FORME QUANTAS PALAVRAS CONSEGUIR USANDO AS LETRAS DE CADA PALAVRA DESTACADA.



EXEMPLO: SOLDADO

DADO, SOL, SOLA, SOLDA,  
SOLO, ETC.



\_\_\_\_\_  
\_\_\_\_\_  
\_\_\_\_\_



\_\_\_\_\_  
\_\_\_\_\_  
\_\_\_\_\_



\_\_\_\_\_  
\_\_\_\_\_  
\_\_\_\_\_



\_\_\_\_\_  
\_\_\_\_\_  
\_\_\_\_\_



# STOP SILÁBICO

ESCREVA O QUE É PEDIDO EM CADA QUADRO, INICIANDO COM A SÍLABA INDICADA.



| <b>NOME PRÓPRIO</b> | <b>ALIMENTO</b> | <b>COR</b> | <b>ANIMAL</b> |
|---------------------|-----------------|------------|---------------|
| <b>BE</b>           | <b>LEI</b>      | <b>PRE</b> | <b>CA</b>     |
| <b>MI</b>           | <b>BA</b>       | <b>A</b>   | <b>SA</b>     |
| <b>LU</b>           | <b>U</b>        | <b>CIN</b> | <b>MA</b>     |
| <b>CA</b>           | <b>AL</b>       | <b>VER</b> | <b>GI</b>     |
| <b>TE</b>           | <b>CE</b>       | <b>LA</b>  | <b>LE</b>     |
| <b>E</b>            | <b>PI</b>       | <b>MAR</b> | <b>BU</b>     |
| <b>GA</b>           | <b>BO</b>       | <b>LI</b>  | <b>ON</b>     |
| <b>LI</b>           | <b>TO</b>       | <b>RO</b>  | <b>FO</b>     |



# JOGO DAS PALAVRAS



ESCREVA PELO MENOS UMA PALAVRA COM CADA UMA DAS SÍLABAS DE CADA FIGURA ABAIXO.



CHU TEI RA

CHUPETA, CHUVEIRO, CHUVA  
TEIA, CARTEIRO, TEIMOSO  
BARATA, RABADA, PARADA

---

---



□ □ □

---

---

---

---

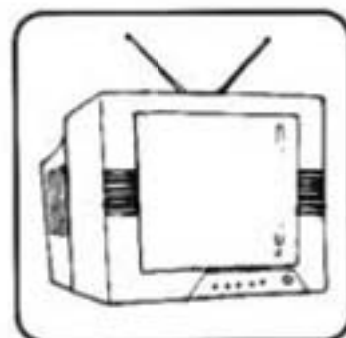

□ □ □ □

---

---

---

---



□ □ □

---

---

---

---



# SÍLABA POR SÍLABA

ESCREVA PELO MENOS DEZ PALAVRAS COM CADA GRUPO DE SÍLABAS  
CADA SÍLABA PODE SER USADA SOMENTE UMA VEZ NA PALAVRA.

PI  
SA  
RI  
CA

DE  
RO  
ZA  
NA

RO  
LO  
A  
SE

VI  
SI  
SO  
DA

LE  
DO  
BE  
A

TU  
MI  
ZE  
RE

# FORMANDO PALAVRAS

USE UMA SÍLABA DO NOME DE CADA FIGURA E ESCREVA OUTRA PALAVRA.

EX:



CAMISA

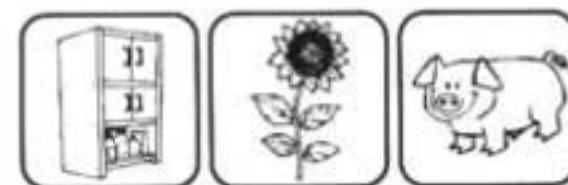
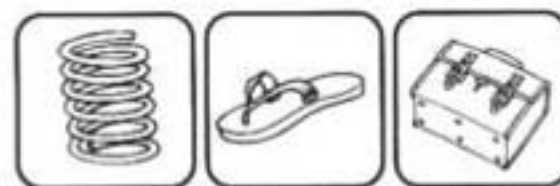
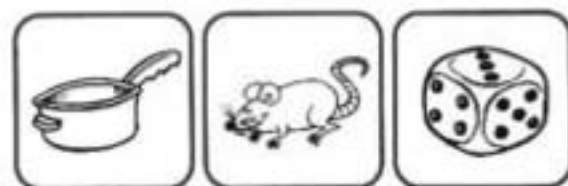



# CAÇA-PALAVRAS

PROCURE NO DIAGRAMA AS CINCO PALAVRAS QUE COMPLETAM CADA GRUPO. MARQUE-AS E ESCREVA-AS NO LUGAR CERTO.

**BRINQUEDOS**

**FLORES**

URBRANCOÇPXNCOMI  
RURSOAMCPIMVINRO  
RRJUDNEVIOLETABN  
OMACAALFĂPMROJNO  
SOMINDRAOXMMRPID  
AHENROQUNBAEHAAB  
URZZCĂEMLIRLCPÇO  
BAMARELOACGHOAĂV  
LABQOGOVOIAORGOA  
ETUCANOERCRLDAOL  
ĂTRMIGRUQLIIAICN  
ORVERDEDETUEDNTORH  
JPIPUTERITAĂOVAA  
AIERNIOADAUKRAVC  
CPOLIBONECAURUOH  
EALTRAARARANEIDA

**CORES**

**ANIMAIS**

# ENCAIXA-SÍLABAS

OBSERVE AS FIGURAS ABAIXO, ESCREVA SEUS NOMES SEPARANDO-OS EM SÍLABAS E ANOTANDO UMA SÍLABA EM CADA QUADRINHO. PINTE OS QUE NÃO FOREM NECESSÁRIOS.



|  |  |  |  |  |
|--|--|--|--|--|
|  |  |  |  |  |
|  |  |  |  |  |
|  |  |  |  |  |
|  |  |  |  |  |
|  |  |  |  |  |
|  |  |  |  |  |
|  |  |  |  |  |
|  |  |  |  |  |
|  |  |  |  |  |
|  |  |  |  |  |
|  |  |  |  |  |
|  |  |  |  |  |
|  |  |  |  |  |
|  |  |  |  |  |
|  |  |  |  |  |
|  |  |  |  |  |

- |                              |                                      |                            |                               |                            |
|------------------------------|--------------------------------------|----------------------------|-------------------------------|----------------------------|
| CACHORRO<br>BORRACHA<br>OSSO | TRAVESSEIRO<br>GIRASSOL<br>CHURRASCO | MOCHILA<br>COELHO<br>MILHO | MANGUEIRA<br>LEQUE<br>MACHADO | TREM<br>PIANO<br>DEZESSETE |
|------------------------------|--------------------------------------|----------------------------|-------------------------------|----------------------------|

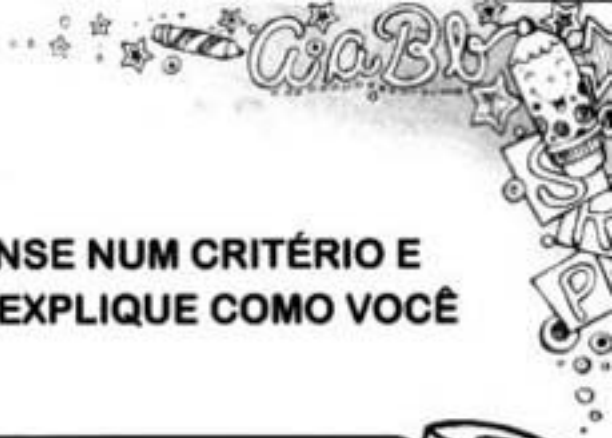

# DESAFIO

CONSIDERANDO AS FAMÍLIAS SILÁBICAS, PENSE NUM CRITÉRIO E FORME GRUPOS COM AS PALAVRAS ABAIXO. EXPLIQUE COMO VOCÊ PENSOU PARA FORMAR ESTES GRUPOS.

CRIME                      PROBLEMA                      PIANO                      TRAVESSEIRO  
TABLETE                      CRAVO                      NEBLINA                      CREME  
                    TRINCO                      CRISE                      BLOCO                      TRUCO                      ACROBACIA                      TREM  
PUDIM                      BLUSA                      POLENTA                      TROVÃO



## 1º GRUPO

---

---

---

## 2º GRUPO

---

---

---

## 3º GRUPO

---

---

---

## 4º GRUPO

---

---











---

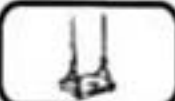
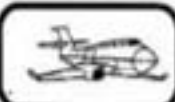
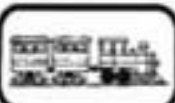

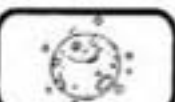

# CADA UM NO SEU LUGAR

REESCREVA OS NOMES ABAIXO NOS ESPAÇOS INDICADOS SEPARANDO EM SÍLABAS E PINTE OS ESPAÇOS QUE VOCÊ NÃO VAI USAR.

|   |  |  |  |  |  |  |
|---|--|--|--|--|--|--|
|    |  |  |  |  |  |  |
|    |  |  |  |  |  |  |
|    |  |  |  |  |  |  |
|    |  |  |  |  |  |  |
|    |  |  |  |  |  |  |
|   |  |  |  |  |  |  |
|  |  |  |  |  |  |  |
|  |  |  |  |  |  |  |
|  |  |  |  |  |  |  |
|  |  |  |  |  |  |  |
|  |  |  |  |  |  |  |
|  |  |  |  |  |  |  |
|  |  |  |  |  |  |  |
|  |  |  |  |  |  |  |



# PENSANDO BEM...

RESPONDA AS QUESTÕES ABAIXO UTILIZANDO AS PALAVRAS DA ATIVIDADE ANTERIOR.

QUAIS PALAVRAS COMEÇAM COM A MESMA SÍLABA?

---

QUAIS PALAVRAS POSSUEM SÍLABAS DE UMA LETRA SÓ?

---

ESCREVA DUAS PALAVRAS QUE COMEÇAM COM A SÍLABA FINAL DE "TARTARUGA". PODEM SER DIFERENTES DAS DO EXERCÍCIO.

---

ESCREVA DUAS PALAVRAS QUE TERMINEM COM A PRIMEIRA SÍLABA DE PATINETE.

---

COMPLETE A TABELA ABAIXO COM AS PALAVRAS DO EXERCÍCIO ANTERIOR, DE ACORDO COM O NÚMERO DE SÍLABAS.



| 1 | 2 | 3 | 4 | 5 |
|---|---|---|---|---|
|   |   |   |   |   |



# PUXA SÍLABAS

ESCREVA UMA PALAVRA COM A ÚLTIMA SÍLABA DE CADA FIGURA

